

# USER MANUAL

TELESTO-III

2609011091000 / 2609011191000

VERSION 2.13

OCTOBER 14, 2024

**WÜRTH ELEKTRONIK** MORE THAN YOU EXPECT

\*\*\*\*\*

## **MUST READ**

### **Check for firmware updates**

Before using the product, make sure you use the most recent firmware version, data sheet, and user manual. This is especially important for Wireless Connectivity products that were not purchased directly from Würth Elektronik eiSos. A firmware update on these respective products may be required.

We strongly recommend including the possibility of a firmware update in the customer system design.

## Revision history

Manual version	FW version	HW version	Notes	Date
1.0	2.1.0	2.3	<ul style="list-style-type: none"> <li>Initial version</li> <li>New corporate design and structure</li> </ul>	November 2018
2.0	2.1.0	2.3	<ul style="list-style-type: none"> <li>Corporate design adaptation</li> </ul>	November 2018
2.1	2.1.0	2.3	<ul style="list-style-type: none"> <li>Added chapter Reference design</li> <li>Added chapter Information for explosion protection</li> </ul>	February 2019
2.2	2.1.0	2.3	<ul style="list-style-type: none"> <li>Updated example in chapter CMD_SET_CHANNEL_REQ</li> </ul>	March 2019
2.3	2.1.0	2.3	<ul style="list-style-type: none"> <li>Updated chapter pinout, marked not needed pin /CTS as RESERVED</li> </ul>	July 2019
2.4	2.5.0	2.3	<ul style="list-style-type: none"> <li>Updated information for firmware version 2.5.0</li> <li>Updated label in chapter General labeling information</li> <li>Updated address of Division Wireless Connectivity &amp; Sensors location</li> </ul>	October 2019

2.5	3.0.0	2.3	<ul style="list-style-type: none"> <li>• Updated the firmware update chapter</li> <li>• Introduced description of transparent mode and related user settings and commands</li> </ul>	June 2020
2.6	3.0.0	2.3	<ul style="list-style-type: none"> <li>• Added known issue: RTS pin behavior when switching from command to transparent mode</li> </ul>	August 2020
2.7	3.0.0	2.3	<ul style="list-style-type: none"> <li>• The description in this user manual of the bit sequence of the user setting <code>OpMode_Flags</code> has been corrected</li> </ul>	March 2021
2.8	3.0.0	2.3	<p>Added details on <i>BOOT</i> pin:</p> <ul style="list-style-type: none"> <li>• Updated chapter <code>Pinout</code></li> <li>• Updated chapter <code>Reference design</code></li> <li>• Updated chapter <code>Quickstart</code></li> <li>• Updated pulldown resistor value for <i>BOOT</i> pin in section <code>Update via ACC software and UART</code></li> </ul>	October 2021
2.9	3.0.0	2.3	<ul style="list-style-type: none"> <li>• Added radiation characteristics in chapter 18.3</li> </ul>	May 2023
2.10	3.0.0	2.3	<ul style="list-style-type: none"> <li>• Added certificates in addition to the required compliance statements in chapter <code>Regulatory compliance information</code></li> </ul>	June 2023

2.11	3.3.0	2.4	<ul style="list-style-type: none"> <li>• Updated for firmware version 3.3.0</li> <li>• Updated description of repeater behavior in chapter 13</li> <li>• Added Listen Before Talk (LBT) in chapter 14</li> <li>• Assigned IDs to known issues, fixed description of KI-005 and added KI-006 in chapter 16.1</li> <li>• Added new command status to CMD_DATA_CNF</li> </ul>	March 2024
2.12	3.3.0	2.4	<ul style="list-style-type: none"> <li>• Extended the information in firmware history with respect to the changes of V3.3.0</li> </ul>	May 2024
2.13	3.3.0	2.4	<ul style="list-style-type: none"> <li>• Added chapter Product testing</li> </ul>	October 2024

\* For firmware history see chapter *Firmware history*

## Abbreviations

Abbreviation	Name	Description
ACK	Acknowledgement	Acknowledgement pattern confirming the reception of the transmitted data packet.
BDM	Business Development Manager	Support and sales contact person responsible for a limited sales area.
CS	Checksum	XOR checksum to check the correct transmission of the prepended Bytes.
CSMA-CA	Carrier Sense Multiple Access - Collision Avoidance	
DC	Duty Cycle	Transmission time in relation of one hour. 1% means, channel is occupied for 36 seconds per hour.
ETA	Equipment Type Approval Certificate	
0xhh [HEX]	Hexadecimal	All numbers beginning with 0x are stated as hexadecimal numbers. All other numbers are decimal, unless otherwise notified.
HIGH	High signal level	Signal level equals VDD.
LBT	Listen Before Talk	Check whether the channel is free before attempting to send a packet.
LNA	Low Noise Amplifier	Electronic module that amplifies weak signals while minimizing noise.
LOW	Low signal level	Signal levels equals 0 Volts.
LPM	Low Power Mode	Operation mode for reduced power consumption.
LRM	Long Range Mode	Transmit mode increasing the reception sensitivity, by using spreading and forward error correction.
LSB	Least Significant Bit	
MSB	Most Significant Bit	
PL	Payload	The real, non-redundant information in a frame / packet.
PSA	Polite Spectrum Access	Set of measures that allow for more flexible use of radio spectrum by devices.
RF	Radio Frequency	Describes everything relating to the wireless transmission.
UART	Universal Asynchronous Receiver Transmitter	The UART allows communicating with the module of a specific interface.

US	User settings	Any relation to a specific entry in the user settings is marked in a special font and can be found in the chapter 8.
VDD	Supply voltage	
WPC	Wireless Planning and Coordination	

# Contents

<b>Overview of helpful application notes</b>	<b>12</b>
<b>1. Introduction</b>	<b>13</b>
1.1. Operational description . . . . .	13
1.2. Block diagram . . . . .	14
1.3. Ordering information . . . . .	15
<b>2. Electrical specifications</b>	<b>16</b>
2.1. Recommended operating conditions . . . . .	16
2.2. Absolute maximum ratings . . . . .	16
2.3. Power consumption . . . . .	17
2.3.1. Static . . . . .	17
2.3.2. Dynamic . . . . .	18
2.4. Radio characteristics . . . . .	19
2.5. Pin characteristics . . . . .	19
<b>3. Pinout</b>	<b>20</b>
<b>4. Quickstart</b>	<b>23</b>
4.1. Minimal pin configuration . . . . .	23
4.2. Power up . . . . .	23
4.3. Quickstart example . . . . .	24
<b>5. Functional description</b>	<b>26</b>
5.1. Operating modes . . . . .	26
5.1.1. Determine operating mode on start-up . . . . .	26
5.1.2. Switching from transparent to command mode . . . . .	27
5.1.3. Switching from command to transparent mode . . . . .	27
5.1.4. Transparent mode . . . . .	27
5.1.5. /RTS signal, module busy . . . . .	28
5.1.6. Command mode . . . . .	28
5.2. Physical layer . . . . .	29
5.3. MAC and network layer . . . . .	29
5.3.1. Addressing modes . . . . .	29
5.3.2. Unicast . . . . .	30
5.3.3. Multicast/Broadcast . . . . .	30
5.3.4. Acknowledgement and retries . . . . .	30
5.3.5. Packet sniffer mode . . . . .	30
5.3.6. Repeater mode and mesh network . . . . .	30
5.4. System configuration parameters . . . . .	30
<b>6. Host connection</b>	<b>32</b>
6.1. Serial interface: UART . . . . .	32
<b>7. The command interface</b>	<b>33</b>
7.1. Overview . . . . .	33



7.2.	Data transfer and reception in the command mode . . . . .	35
7.2.1.	CMD_DATA_REQ . . . . .	35
7.2.2.	CMD_DATAEX_REQ . . . . .	35
7.2.3.	CMD_DATAEX_IND . . . . .	37
7.2.4.	CMD_REPEAT_IND . . . . .	38
7.2.5.	CMD_DUTYCYCLE_IND . . . . .	39
7.2.5.1.	Example . . . . .	39
7.3.	Requesting parameters, actions and events . . . . .	40
7.3.1.	CMD_RESET_REQ . . . . .	40
7.3.2.	CMD_RESET_IND . . . . .	40
7.3.3.	CMD_SHUTDOWN_REQ . . . . .	40
7.3.4.	CMD_STANDBY_REQ . . . . .	41
7.3.5.	CMD_STANDBY_IND . . . . .	41
7.3.6.	CMD_RSSI_REQ . . . . .	42
7.4.	Modification of volatile parameters . . . . .	43
7.4.1.	CMD_SET_PAPOWER_REQ . . . . .	43
7.4.1.1.	Example . . . . .	43
7.4.2.	CMD_SET_CHANNEL_REQ . . . . .	43
7.4.2.1.	Example . . . . .	44
7.4.3.	CMD_SET_DESTNETID_REQ . . . . .	44
7.4.4.	CMD_SET_DESTADDR_REQ . . . . .	45
7.4.5.	CMD_SET_MODE_REQ . . . . .	45
7.5.	Modification of non-volatile parameters . . . . .	46
7.5.1.	CMD_SET_REQ . . . . .	46
7.5.2.	CMD_GET_REQ . . . . .	47
7.5.3.	CMD_FACTORY_RESET_REQ . . . . .	47
7.6.	Message overview . . . . .	49
<b>8.</b>	<b>User settings - Module configuration values</b>	<b>50</b>
8.1.	Difference between volatile and non-volatile settings . . . . .	50
8.2.	Modifying the user settings . . . . .	50
8.2.1.	UART_Baudrate: Configure the UART speed . . . . .	50
8.2.1.1.	Example 1 . . . . .	51
8.2.1.2.	Example 2 . . . . .	51
8.2.2.	RADIO_DefaultRfProfile: Configure the RF-settings . . . . .	52
8.2.2.1.	Example 1 . . . . .	52
8.2.2.2.	Example 2 . . . . .	52
8.2.3.	RADIO_DefaultRfTXPower: Configure the RF TX-power . . . . .	54
8.2.3.1.	Example 1 . . . . .	54
8.2.3.2.	Example 2 . . . . .	54
8.2.4.	RADIO_DefaultRfChannel: Configure the RF channel . . . . .	55
8.2.4.1.	Example 1 . . . . .	55
8.2.4.2.	Example 2 . . . . .	55
8.2.5.	MAC_DefaultAddressMode: Configure the address mode . . . . .	57
8.2.5.1.	Example 1 . . . . .	58
8.2.5.2.	Example 2 . . . . .	58
8.2.6.	MAC_NumRetrys: Configure the number of retries . . . . .	59
8.2.6.1.	Example 1 . . . . .	59

8.2.6.2.	Example 2 . . . . .	59
8.2.7.	MAC_DefaultDestNetID: Configure the destination network ID . . . . .	61
8.2.7.1.	Example 1 . . . . .	61
8.2.7.2.	Example 2 . . . . .	61
8.2.8.	MAC_DefaultDestAddr: Configure the destination address . . . . .	62
8.2.8.1.	Example 1 . . . . .	62
8.2.8.2.	Example 2 . . . . .	62
8.2.8.3.	Example 3 . . . . .	62
8.2.9.	MAC_SourceNetID: Configure the source network ID . . . . .	64
8.2.9.1.	Example 1 . . . . .	64
8.2.9.2.	Example 2 . . . . .	64
8.2.10.	MAC_SourceAddr: Configure the source address . . . . .	65
8.2.10.1.	Example 1 . . . . .	65
8.2.10.2.	Example 2 . . . . .	65
8.2.10.3.	Example 3 . . . . .	65
8.2.11.	OpMode: Default operating mode of the module . . . . .	67
8.2.11.1.	Example 1 . . . . .	67
8.2.11.2.	Example 2 . . . . .	67
8.2.12.	OpMode_Flags: Configure transmission trigger for transparent mode . . . . .	68
8.2.12.1.	Example 1 . . . . .	68
8.2.12.2.	Example 2 . . . . .	69
8.2.13.	UART_Timeout: Configure timeout for transparent mode . . . . .	70
8.2.13.1.	Example 1 . . . . .	70
8.2.13.2.	Example 2 . . . . .	70
8.2.14.	UART_ETX_Character0: Configure ETX characters for transparent mode . . . . .	71
8.2.14.1.	Example 1 . . . . .	71
8.2.14.2.	Example 2 . . . . .	71
8.2.14.3.	Example 3 . . . . .	72
8.2.15.	UART_ETX_Character1: Configure ETX character for transparent mode . . . . .	73
8.2.15.1.	Example 1 . . . . .	73
8.2.15.2.	Example 2 . . . . .	73
8.2.16.	CfgFlags: Configure the configuration flags of the module . . . . .	74
8.2.16.1.	Example 1 . . . . .	74
8.2.16.2.	Example 2 . . . . .	74
8.2.17.	RpFlags: Configure the repeater flags of the module . . . . .	76
8.2.17.1.	Example 1 . . . . .	76
8.2.17.2.	Example 2 . . . . .	77
8.2.18.	RP_NumSlots: Configure the repeater data base . . . . .	78
8.2.18.1.	Example 1 . . . . .	79
8.2.18.2.	Example 2 . . . . .	79
8.2.19.	LBT_ObservationPeriod: Configure the observation period for LBT . . . . .	80
8.2.19.1.	Example 1 . . . . .	80
8.2.19.2.	Example 2 . . . . .	80
8.2.20.	LBT_Threshold: Configure the RSSI threshold for LBT . . . . .	81
8.2.20.1.	Example 1 . . . . .	81
8.2.20.2.	Example 2 . . . . .	81
8.2.21.	FactorySettings: Read out the factory settings . . . . .	82
8.2.21.1.	Example 1 . . . . .	82

8.2.22. FirmwareVersion: Read out the firmware version . . . . .	83
8.2.22.1. Example 1 . . . . .	83
<b>9. Timing parameters</b>	<b>84</b>
9.1. Reset behavior . . . . .	84
9.1.1. Reset via /RESET pin . . . . .	84
9.1.2. Reset as result of a serious error condition . . . . .	84
9.2. Latencies when leaving standby or shutdown . . . . .	84
9.2.1. Wake-up latency from standby . . . . .	84
9.2.2. Wake-up latency from shutdown . . . . .	85
9.3. Latencies during data transfer / packet generation . . . . .	85
<b>10. Radio parameters</b>	<b>86</b>
10.1. Channel assignment . . . . .	86
<b>11. Battery powered operation</b>	<b>88</b>
<b>12. Custom firmware</b>	<b>89</b>
12.1. Custom configuration of standard firmware . . . . .	89
12.2. Customer specific firmware . . . . .	89
12.3. Customer firmware . . . . .	89
12.4. Contact for firmware requests . . . . .	90
<b>13. Flooding mesh: Using the repeater functionality</b>	<b>91</b>
13.1. Setup of the network and repeater device . . . . .	92
13.2. Example network . . . . .	93
13.2.1. Application in parallel networks . . . . .	94
<b>14. Listen Before Talk (LBT)</b>	<b>95</b>
<b>15. Firmware updates</b>	<b>96</b>
15.1. Firmware flashing using the production interface . . . . .	96
15.2. Update via ACC software and UART . . . . .	96
<b>16. Firmware history</b>	<b>98</b>
16.1. Known issues . . . . .	98
<b>17. Design in guide</b>	<b>101</b>
17.1. Advice for schematic and layout . . . . .	101
17.2. Designing the antenna connection . . . . .	103
17.3. Antenna solutions . . . . .	104
17.3.1. Wire antenna . . . . .	105
17.3.2. Chip antenna . . . . .	105
17.3.3. PCB antenna . . . . .	105
17.3.4. Antennas provided by Würth Elektronik eiSos . . . . .	106
17.3.4.1. 2600130086 - Hermippe-III dipole antenna . . . . .	106
17.3.4.2. 2600130083 - Hydra-I dipole antenna . . . . .	107
<b>18. Reference design</b>	<b>108</b>
18.1. Schematic . . . . .	108

18.2. Layout . . . . .	111
18.3. Internal antenna radiation characteristics . . . . .	113
<b>19. Manufacturing information</b>	<b>114</b>
19.1. Moisture sensitivity level . . . . .	114
19.2. Soldering . . . . .	114
19.2.1. Reflow soldering . . . . .	114
19.2.2. Cleaning . . . . .	115
19.2.3. Potting and coating . . . . .	116
19.2.4. Other notations . . . . .	116
19.3. ESD handling . . . . .	116
19.4. Safety recommendations . . . . .	117
<b>20. Product testing</b>	<b>118</b>
20.1. Würth Elektronik eiSos in-house production tests . . . . .	118
20.2. EMS production tests . . . . .	118
<b>21. Physical specifications</b>	<b>120</b>
21.1. Dimensions . . . . .	120
21.2. Weight . . . . .	120
21.3. Module drawing . . . . .	121
21.4. Footprint . . . . .	122
21.5. Antenna free area . . . . .	122
<b>22. Marking</b>	<b>123</b>
22.1. Lot number . . . . .	123
22.2. General labeling information . . . . .	124
<b>23. Information for explosion protection</b>	<b>125</b>
<b>24. Regulatory compliance information</b>	<b>126</b>
24.1. Important notice FCC . . . . .	126
24.2. Conformity assessment of the final product . . . . .	126
24.3. Exemption clause . . . . .	126
24.4. FCC Compliance Statement (US) . . . . .	127
24.4.1. FCC certificate . . . . .	127
24.5. IC Compliance Statement (Canada) . . . . .	128
24.5.1. IC certificate . . . . .	128
24.6. FCC and IC requirements to OEM integrators . . . . .	129
24.7. Pre-certified antennas . . . . .	130
<b>25. Important notes</b>	<b>131</b>
<b>26. Legal notice</b>	<b>131</b>
<b>27. License terms</b>	<b>132</b>
<b>A. Additional CRC8 Information</b>	<b>135</b>
A.1. Example CRC8 Implementation . . . . .	135
A.2. CRC8 Test Vectors . . . . .	135



**B. Example code for host integration**

**136**

## Overview of helpful application notes

### **Application note ANR008 - Wireless Connectivity Software Development Kit**

<http://www.we-online.com/ANR008>

To ease the integration of the Würth Elektronik eiSos radio modules into an application, Würth Elektronik eiSos offers the corresponding Software Development Kit (SDK) for most commonly used host processors. This SDK contains drivers and examples in C-code to communicate with the corresponding radio module. This application note shows which SDKs are available and describes how to download and use them.

### **Application note ANR010 - Range estimation**

<http://www.we-online.com/ANR010>

This application note presents the two most used mathematical range estimation models, Friis and two ray ground reflection, and its implementation in the range estimation tool of the RED-EXPERT.

### **Application note ANR015 - From 868 MHz To 915 MHz**

<http://www.we-online.com/ANR015>

Due to radio regulation laws in Europe and North America different frequencies are used in the sub-GHz range for radio data transmission. Therefore Würth Elektronik eiSos offers each product operating in the European 868 MHz range an counterpart operating in the American 915 MHz range. This application note shows which modules are comparable, where they differ and what to consider when switching from 868 to 915 MHz and vice versa.

### **Application note ANR016 - Radio module migration guide**

<http://www.we-online.com/ANR016>

Due to our long term availability policy Würth Elektronik eiSos offers beside radio modules with most recent technology and chipset still the predecessor modules. This application note describes what to consider when switching in between module generations.

# 1. Introduction

This manual is valid for following Telesto-III variants:

- 2609011191000
- 2609011091000

## 1.1. Operational description

The Telesto-III is a radio module for wireless communication between devices, such as control systems, remote controls, sensors, etc. It offers several radio configurations, address modes and relieves the host system of radio-specific tasks such as

- checksum calculation,
- address resolution and
- repetition of unacknowledged telegrams, if enabled.

It can be deployed wherever the wireless exchange of data packets among two or more parties is required. A serial interface (UART), whose data rate and format can be adjusted flexibly, is available for communicating with the host system.

## 1.2. Block diagram

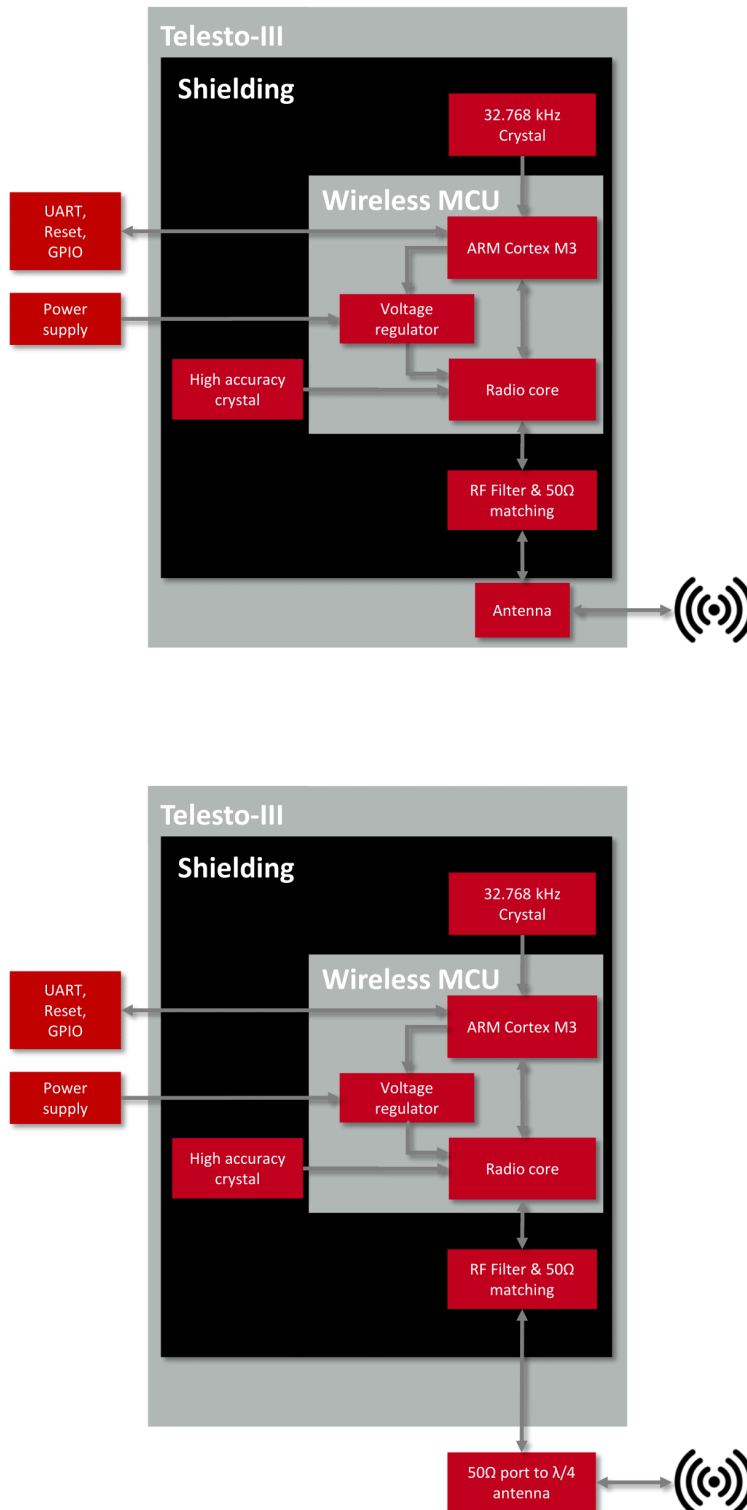

Figure 1: Block diagram of the module variants with internal PCB antenna and antenna pad



### 1.3. Ordering information

WE order code	Former order code	Description
2609011091000	AMB9826-TR	Radio module 915 MHz with integrated PCB antenna, Tape & Reel
2609011191000	AMB9826-1-TR	Radio module 915 MHz with RF pad, Tape & Reel
2609019291001	AMB9826-1-EV	EV-Kit with module AMB9826-1
2609026291001	AMB9865	Radio dongle 915 MHz with SMA connector

Table 1: Ordering information

## 2. Electrical specifications

If not otherwise stated, the following parameters have been measured on the EV-Board Telesto-III-EV with  $T = 25\text{ °C}$ ,  $VDD = 3.0\text{ V}$ , internal DC-DC converter active and a  $50\ \Omega$  connection. Any radio transmission in the standard firmware uses boost mode, independent of the chosen output power.

### 2.1. Recommended operating conditions

Description	Min.	Typ.	Max.	Unit
Ambient temperature	-40	25	85	°C
Supply voltage (VDD)	2.2 <sup>1</sup>	3.0	3.7	V
Rising supply voltage slew rate	0		100	mV/ $\mu$ s
Falling supply voltage slew rate	0		20	mV/ $\mu$ s
Falling supply voltage slew rate, with low power flash settings			3	mV/ $\mu$ s

Table 2: Recommended operating conditions

### 2.2. Absolute maximum ratings

Description	Min.	Typ.	Max.	Unit
Supply voltage (VDD)	-0.3		4.1	V
Voltage on any digital pin	-0.3		VDD + 0.3, max 4.1	V
Input RF level			10	dBm
Output RF level, with boost mode		14		dBm

Table 3: Absolute maximum ratings

<sup>1</sup>Below 2.2 V, the chipset stops working immediately. A certain buffer for voltage drops should be considered, e.g. when supplying with 2.4 V.

## 2.3. Power consumption



As a DC/DC voltage regulator is integrated, the current consumption is strongly depending on the supplied voltage level.



The transmit and receive currents are depending on the impedance matching and therefore may vary depending on antenna selection and matching.



The indicated values are the complete current consumption for radio and active MCU. Not to be confused with only radio or only CPU core currents, as sometimes stated by others.



A stable power supply is indispensable to ensure valid operating conditions for the module.

### 2.3.1. Static

Current consumption is the sum of the CPU current and radio TX or RX current in active modes. Measurements on Telesto-III-EV with  $T = 25\text{ °C}$ ,  $VDD = 3.0\text{ V}$ , internal DC-DC converter active and a  $50\ \Omega$  connection, unless specified otherwise.

Description	Typ.	Unit
TX current 10 dBm output power, boost mode	17	mA
TX current 14 dBm output power, boost mode	26	mA
RX current	8	mA
Low power (standby) radio off, UART off, RTC running, full RAM retention	1.6	$\mu\text{A}$
Low power (shutdown) radio off, UART off, RTC off, no RAM retention	0.2	$\mu\text{A}$

Table 4: Power consumption @3.6 V

**2.3.2. Dynamic**

Measurements on Telesto-III-EV with T = 25 °C, internal DC-DC converter active and a 50 Ω connection unless specified otherwise.

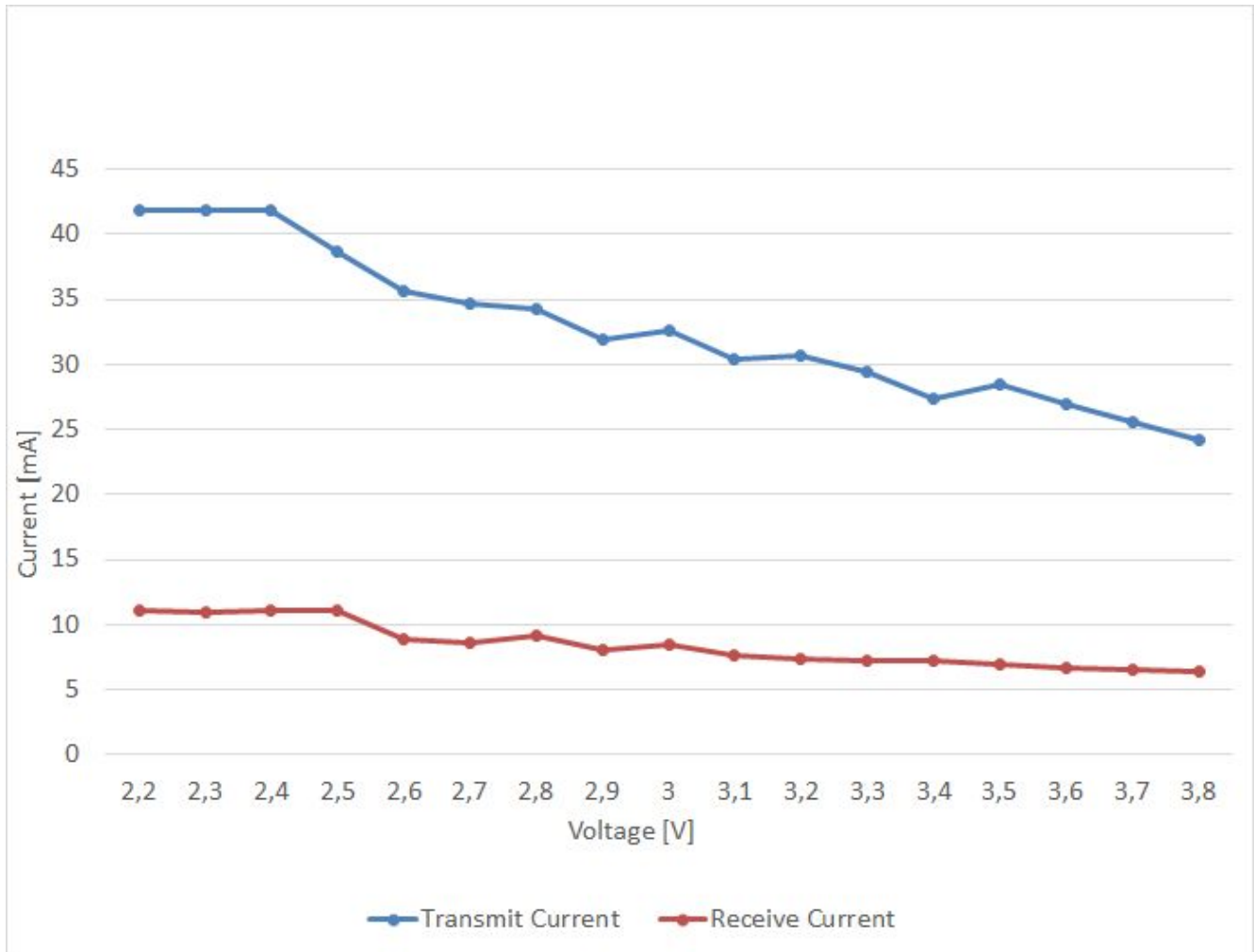

Figure 2: Typical behavior of transmit and receive current in relation to applied supply voltage

## 2.4. Radio characteristics

Description	Min.	Typ.	Max.	Unit
Frequency band	902.5	905	927.5	MHz
Radio data rate	400	400	400	kbit/s
RX sensitivity		-96		dBm
TX power	0	14	14	dBm

Table 5: Radio characteristics

## 2.5. Pin characteristics

Property	typ. Value	Unit
Default GPIO maximum current	2	mA
Maximum current of <i>RX_IND, TX_IND</i>	4	mA
Pull up current VDD=1.8 V	71.7	µA
Pull down current VDD=1.8 V <sup>2</sup>	21.1	µA
Pull up current VDD=3.8 V	277	µA
Pull down current VDD=3.8 V	113	µA
V <sub>IH</sub> , Lowest GPIO input voltage reliably interpreted as a HIGH	0.8 * VDD	V
V <sub>IL</sub> , Highest GPIO input voltage reliably interpreted as a LOW	0.2 * VDD	V

Table 6: Pin characteristics

<sup>2</sup>The module overall is not specified for 1.8 V, as the output amplifier needs minimum 2.2 V. Nevertheless, the GPIOs are specified from Texas Instruments with this value.

### 3. Pinout

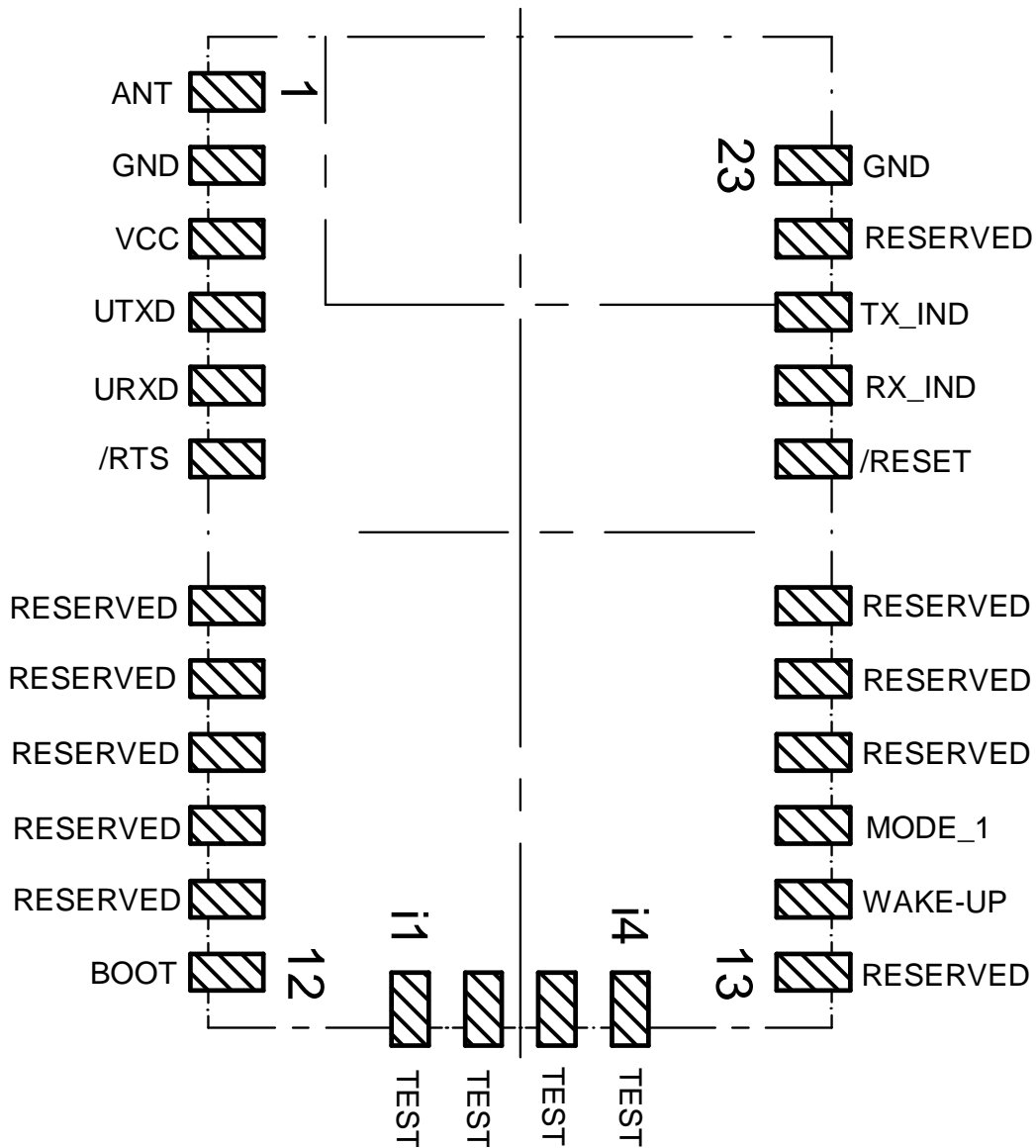

Figure 3: Pinout (top view)

No	Designation	I/O	Description
1	<i>ANT</i>		Antenna connector 50 Ω used in Telesto-III with external antenna only, RESERVED otherwise
2	<i>GND</i>	Supply	Ground
3	<i>VCC</i>	Supply	Supply voltage
4	<i>UTXD</i>	Output	UART module TX

5	<i>URXD</i>	Input	UART module RX, uses internal pull-up.
6	<i>/RTS</i>	Output	UART Flow Control. Module busy = HIGH.
7	RESERVED	I/O	Reserved for future use. Uses an internal pull-up. Do not connect.
8	RESERVED	I/O	Reserved for future use. Uses an internal pull-down. Do not connect.
9	RESERVED	I/O	Reserved for future use. Uses an internal pull-down. Do not connect.
10	RESERVED	I/O	Reserved for future use. Uses an internal pull-down. Do not connect.
11	RESERVED	I/O	Reserved for future use. Uses an internal pull-down. Do not connect.
12	<i>BOOT</i>	Input	Connect LOW level to use application firmware. Connect HIGH level or leave open to enable the UART bootloader for firmware updates. Uses internal pull up during start up sequence. Details see chapter <i>Quickstart</i> .
13	RESERVED	I/O	Reserved for future use. Uses an internal pull-down. Do not connect.
14	<i>WAKE-UP</i>	Input	Apply a falling edge to wake-up from shutdown or standby mode. Uses an internal pull-down.
15	<i>MODE_1</i>	I/O	Starts in <i>OpMode</i> (default: command mode) when left unconnected. Apply LOW level during boot to start-up in command mode. Apply HIGH level during boot to start-up in transparent mode. The respective level shall also be steadily applied during normal module operation to prevent leakage current.
16	RESERVED	I/O	Reserved for future use. Uses an internal pull-down. Do not connect.
17	RESERVED	I/O	Reserved for future use. Uses an internal pull-down. Do not connect.
18	RESERVED	I/O	Reserved for future use. Uses an internal pull-down. Do not connect.
19	<i>/RESET</i>	Input	Uses an internal pull-up. LOW holds the module in reset state.
20	<i>RX_IND</i>	Output	Indicates RF data reception, active = high.
21	<i>TX_IND</i>	Output	Indicates RF data transmission, active = high.
22	RESERVED	I/O	Reserved for future use. Uses an internal pull-down. Do not connect.

23	<i>GND</i>	Supply	Ground
i1	<i>TEST</i>	Input	Debug interface. Do not connect.
i2	<i>TEST</i>	Input	Debug interface. Do not connect.
i3	<i>TEST</i>	Input	Debug interface. Do not connect.
i4	<i>TEST</i>	Input	Debug interface. Do not connect.

Table 7: Pinout



## 4. Quickstart

### 4.1. Minimal pin configuration

In factory state, the module is immediately ready for operation in command mode. The following pins are required in the minimal configuration:

*/RESET*, *BOOT*, *VCC*, *GND*, */RTS*, *UTXD* and *URXD*

The antenna pad *ANT* must be connected accordingly, in case it is used.

If the module is connected to a PC or non 3.3 V logic level, a converter cable/IC (e.g. 3.3 V TTL to USB) is necessary to achieve interface compatibility. The Telesto-III-EV already implements such a USB converter to be connected to a PC. Not interpreting the */RTS* line of the module as described in this manual, may cause undefined behavior and data loss.

During the start up sequence, the voltage level on *BOOT* pin is checked. To start the application firmware, the level must be LOW. As an internal pull-up resistor is switched inside the chip during the start up sequence, it is necessary to connect LOW level via pull-down resistor or host processor.

The pull-down resistor should have a low value, for example 220  $\Omega$ , to work against the internal pull-up with a value of 13-26 k $\Omega$ , depending on the supply voltage level. After the start up sequence finishes, the *BOOT* pin switches to high impedance to avoid current consumption. Connecting the *BOOT* pin fix to a LOW level, will prevent the possibility of a firmware update.

### 4.2. Power up

Recommended procedure for starting the module into normal operation:  
Set and hold the *BOOT* and *RESET* pin to LOW.

After supply voltage is applied to the module and has stabilized, the */RESET* pin shall be tied to LOW level for another  $\Delta t$  of at least 1 ms, to ensure a safe start-up when releasing or applying HIGH to the */RESET* pin.

The module will send a *CMD\_RESET\_IND* UART message as well as pulling the */RTS* line to LOW once it has booted and started the application.

Then the *BOOT* pin may be either released or kept at LOW level.

If the module is used on a battery-powered system, using a matching reset-IC (or a discrete RC block for a delay) is highly recommended to ensure a correct power up and stable behavior towards a battery getting empty. Optional: For activating the transparent mode, the *MODE\_1* pin has to be connected and held HIGH before the */RESET* pin is HIGH.

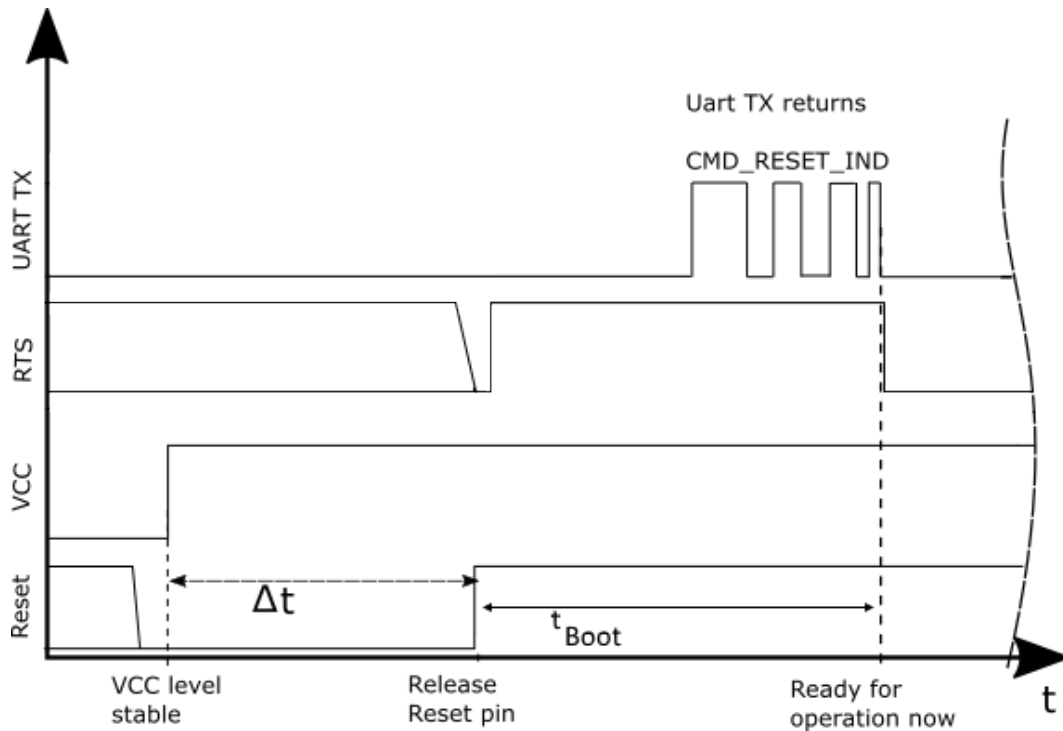

Figure 4: Power up

### 4.3. Quickstart example

#### Sending and receiving: Hello World

Connect the two devices (modules, EV-boards or USB dongles) to a PC. You may need to install FTDI VCP drivers manually (see *FTDI*) or using Windows update. A minimum distance of 2 meters between the two devices should be kept at all times, in order to avoid over-modulation of the receiver.

A terminal program, for example *hterm*, is used to perform the communication via COM ports. The two corresponding COM ports have to be selected and opened with a default configuration of 115200 Baud, 8 data bits, 1 stop bit and parity set to none (8n1).



It needs to be assured that the received data is shown also in hex format, by enabling the corresponding checkbox:

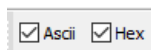

As soon as the module is ready for operation (at start-up or after a reset), it sends a `CMD_RESET_IND` message on the UART. It may be necessary to push the reset button (or perform `CMD_RESET_REQ`) to trigger a reset and see this message.

Next, the command interface can be used to configure the module or to transmit data. The

MAC\_DefaultAddressMode is 0, which means that all radio frames are broadcasts that can be received by any other compatible radio device with default settings.

To send the string "Hello World", the corresponding CMD\_DATA\_REQ has to be inserted into the input line of hterm. The "Type" needs to be changed from "ASC" to "HEX" before entering the first byte. The command CMD\_DATA\_REQ has the following structure:

Start signal	Command	Length	Payload	CS
0x02	0x00	1 byte	Length Bytes	1 byte

In this example, the payload 0x48 0x65 0x6C 0x6C 0x6F 0x20 0x57 0x6F 0x72 0x6C 0x64 0x21 (Hello World!) has a length of 12 (0x0C) Bytes. The checksum CS is an XOR combination of all previous bytes, which is 0x0F in this case.

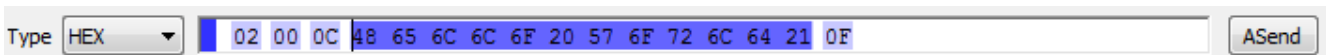

Using the "ASend" button followed by pushing the "Start" button, sends the data once. The second module receiving this packet, outputs a CMD\_DATAEX\_IND message containing the transmitted payload data and the corresponding RSSI value.

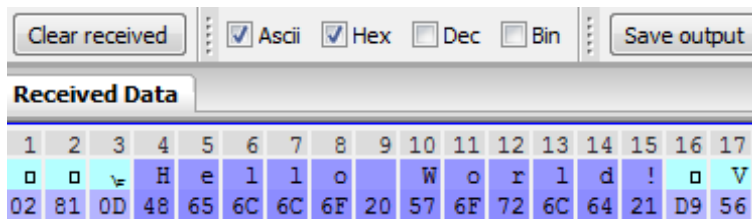

In the default address mode (MAC\_DefaultAddressMode = 0), the format of the CMD\_DATAEX\_IND is as follows:

Start signal	Command	Length	Payload	RSSI	CS
0x02	0x81	1 byte	(Length-1) Bytes	1 byte	1 byte

Thus, the CMD\_DATAEX\_IND message informs us that we received a packet with payload of 13 (0x0D) Bytes. 12 of these Bytes are the transmitted user payload 0x48 0x65 0x6C 0x6C 0x6F 0x20 0x57 0x6F 0x72 0x6C 0x64 0x21 (Hello World!) and one byte is the RSSI value, here 0xD9 (-39dBm in two's complement notation).

## 5. Functional description

The Telesto-III can be configured to operate in several modes at the physical, MAC, as well as the network layer. This chapter describes all the available modes of operation.

### 5.1. Operating modes

The Telesto-III can be used in the following operating modes:

1. Transparent mode (transparent data transmission) or
2. Command mode (module configuration and data transmission, using the predefined command interface).

The operating mode after power-up can be configured by means of the `OpMode` parameter and the level of the `MODE_1`. By default, the module operates in command mode. Starting in command mode, the module responds with a `CMD_RESET_IND` telegram.



We highly recommend to only use command mode. The *Wireless Connectivity SDK* provides all the commands needed for Telesto-III as C source code.

#### 5.1.1. Determine operating mode on start-up

During the start-up routine, the module checks the level of the `MODE_1` pin. If a LOW level is detected, the module starts in command mode. If a HIGH level is detected, the module starts in transparent mode. In case of a floating `MODE_1` pin, the `OpMode` parameter is used (default: command mode).



The level of the `MODE_1` pin has a higher priority than the user setting `OpMode`.

<code>MODE_1</code> pin	Operating mode
LOW level detected	Command mode
HIGH level detected	Transparent mode
Floating detected	As defined in <code>OpMode</code>

Table 8: Operating mode at start-up

### 5.1.2. Switching from transparent to command mode

The command mode can be entered by transmitting the escape sequence "+++" (= 0x2B 0x2B 0x2B) via UART during runtime. The escape sequence has to be the only data in the UART RX buffer. In case of an ongoing radio transmission, the operating mode will be switched once the transmission is finished.

The recommended procedure is:

1. Wait at least 4 byte durations since last transmission to module,
2. Send the escape sequence 0x2B2B2B,
3. Wait until a `CMD_SET_MODE_CNF` is sent by the module.

The successful switchover is acknowledged by a `CMD_SET_MODE_CNF` telegram indicating command mode.

### 5.1.3. Switching from command to transparent mode

The transparent mode can be entered by using the command `CMD_SET_MODE_REQ` during runtime. In case of an ongoing radio transmission, the operating mode will be switched once the transmission is finished.

The successful switchover is acknowledged by a `CMD_SET_MODE_CNF` telegram indicating transparent mode.

### 5.1.4. Transparent mode



Applications should not use the data 0x2b2b2b anywhere in the data stream of transparent payload data. This 3 byte sequence is reserved for switching to command mode.

In this mode, data is received via the serial interface and initially buffered. As soon as a specific condition is met, the RF telegram is generated with a preamble, checksum and address information.

Radio transmission in transparent mode behaves the same as `CMD_DATA_REQ` in command mode and uses the configured address information of the corresponding user settings.

The transparent mode does not inform the host if and how many data was sent.

To initiate an RF transmission, several options are available, as listed in table 9.

Start condition	Description	Dependent user settings
<b>Timeout</b>	Transmission starts if no new character is detected within a configurable period of time after receiving a character via UART. The timeout is reset every time a new character is received.	OpMode_Flags, UART_Timeout
<b>End-of-text-character</b>	Transmission begins when the preconfigured characters are transmitted via UART. End-Of-Text-Character can be one or two Bytes long.	OpMode_Flags, UART_ETX_Character0, UART_ETX_Character1
<b>Maximum packet size</b>	Transmission starts when the maximum number of Bytes is reached in the RX buffer of the UART. The maximum number of Bytes depends on the selected RADIO_DefaultRfProfile. This condition is always active and can not be disabled.	RADIO_DefaultRfProfile

Table 9: Communication in transparent mode

The OpMode\_Flags parameter (see chapter 8.2.12) can be used to determine which of the listed combinations is to be used.

**5.1.5. /RTS signal, module busy**

/RTS signalizes a busy UART buffer of the module, which means, when /RTS is set HIGH, all incoming UART Bytes will be discarded. /RTS is set when any of the events in the prior chapter has occurred.

Due to the control of the /RTS pin by the operating system, there may be a latency between the pin and the internal state. To prevent a too early use of the module, an additional delay of  $\geq 100\mu\text{s}$  shall be implemented by the host when /RTS shows an edge from HIGH to LOW.



The /RTS pin handling shall be implemented into the host, in order to prevent data loss.

**5.1.6. Command mode**

This operating mode primarily serves module configuration. The module acts as a slave and can be fully controlled by an external host using the commands of the command interface (see chapter 7).

It can also be used for wireless transmission of payload data, providing a feedback dependent on the transmission success.

## 5.2. Physical layer

At the physical layer, the Telesto-III can be configured to use one of the following radio profiles (see parameter `RADIO_DefaultRfProfile`).

Radio profile	Data rate (gross) [kcps]	Modulation	Max packet size [byte]
6	400	GFSK	224

Additionally, the frequency channel of operation is configurable to avoid interference between several subnets of radio devices (see `RADIO_DefaultRfChannel`). The radio parameters need to be chosen for optimal performance based on the required range, data rate and maximum payload size, keeping in mind the compliance with valid regulatory requirements. A detailed description for configuring these parameters can be found in chapter 7 and chapter 8.

## 5.3. MAC and network layer

### 5.3.1. Addressing modes

In order to interconnect several modules and build a network or to send data to specific devices, the Telesto-III supports addressing at MAC and network levels. Based on the address mode of the module configured using the user setting `MAC_DefaultAddressMode`, each device can be configured with an address (1 or 2 byte) and a network ID (1 byte) that is defined by the user settings `MAC_SourceAddr` and `MAC_SourceNetID`, respectively.

Address mode	MAC address size [byte]	Network address size [byte]
0	0	0
1	1	0
2	1	1
3	2	1

Depending on the selected address mode, up to 254 network IDs and up to 65,534 addresses are supported. `0xFF` and `0xFFFF` are used as broadcast addresses.



Note that the RF settings (e.g. RF profile, RF channel, address mode, repeater settings) must be the same for all nodes in the network.

Violation may cause interrupted transmission or received packets that cannot be interpreted correctly. In addition, the timing parameters, in case of repeater or enabled ACKs, must be the same for all nodes in a network.

Radio messages of devices that are using the same radio channel may interfere with each other, leading to possible collisions and packet loss.

### 5.3.2. Unicast

A module can use the command `CMD_DATA_REQ` to send data to a pre-defined destination, specified by the parameters `MAC_DefaultDestAddr` and `MAC_DefaultDestNetID`. Besides this, the command `CMD_DATAEX_REQ` triggers the data transmission to the address specified in the command.

### 5.3.3. Multicast/Broadcast

The destination address or destination network ID of `0xFF` (255) or `0xFFFF` (65535), stands for a broadcast, which will trigger any compatible receiver to interpret this frame to forward it to its host.

### 5.3.4. Acknowledgement and retries

In order to improve reliability in communication, the module can be configured to use the radio ACK and retry mechanism. It can be activated using the parameter `MAC_NumRetrys` accordingly and only in case of non-broadcast messages.

### 5.3.5. Packet sniffer mode

The address resolution can be disabled ("packet sniffer") by enabling the sniffer mode in the user setting `CfgFlags`. A module in sniffer mode will accept all data packets (ignoring the target address) and forward them to the serial interface. Furthermore, it does not send any ACK and cannot work as repeater at the same time (see section 13).

### 5.3.6. Repeater mode and mesh network

The module can be run as a repeater to artificially extend the range of sending devices in an existing network. A module configured as repeater, simply re-transmits the received packet after a random back-off time. This mode allows options to build a "flooding mesh" network, described in detail in chapter 13.

## 5.4. System configuration parameters

The parameters that determine the functionality of the module, are classified into two categories. The non-volatile user settings (see chapter 8) values that can be modified using the `CMD_SET_REQ` command retain their values after a power reset.





Note that each `CMD_SET_REQ` will consume one flash erase/write cycle, which is limited due to the hardware (100,000 cycles guaranteed, see TI CC1310 datasheet).

On the other hand, the volatile settings (called "Runtime settings") can be accessed by explicit commands (see chapter 7.4) and used to quickly (but temporarily) modify specific parameters without using flash cycles. These settings are only valid until a reset is performed and shall be used when frequent updates of settings are necessary.

## 6. Host connection

### 6.1. Serial interface: UART

The configuration in factory state of the UART is 115200 Baud with data format of 8 data bits, no parity and 1 stop bit ("8n1"). The baud rate of the UART can be configured by means of the user setting `UART_Baudrate`. The data format is fixed to 8n1.

The output of characters on the serial interface runs with secondary priority. For this reason, short interruptions may occur between the outputs of individual successive Bytes. The host must not implement too strict timeouts between two Bytes, in order to be able to receive packets that have interruptions in between. At least four full byte durations (32 bits) delay between two successive Bytes shall be accepted by the host.

For the direction "host to module", the host must respect byte-wise the line `/RTS`, which will indicate that the next byte of the packet can be received by the module. This direction also accepts a pause of up to four full byte durations (32 bits) delay between two successive Bytes, before discarding received content (without user notification). To prevent a too early use of the module, an additional delay of  $\geq 100\mu\text{s}$  shall be implemented by the host when `/RTS` shows an edge from HIGH to LOW (i.e. module switches from busy to idle).

## 7. The command interface

### 7.1. Overview

The module acts as a slave and can be fully controlled by an external host. The configuration as well as the operation of the module can be managed by predefined commands that are sent as telegrams over the UART interface of the module.

The commands of the command interface can be divided into 3 groups:

- **Requests:** The host requests the module to trigger any action, e.g. in case of the request `CMD_RESET_REQ` the host asks the module to perform a reset.
- **Confirmations:** On each request, the module answers with a confirmation message to give a feedback on the requested operation status. In case of a `CMD_RESET_REQ`, the module answers with a `CMD_RESET_CNF` to tell the host whether the reset will be performed or not.
- **Indications and Responses:** The module indicates spontaneously when a special event has occurred. The `CMD_DATAEX_IND` indicates for example that data was received via radio.

Start signal	Command	Length	Payload	CS
0x02	1 Byte	1 Byte	Length Bytes	1 Byte

**Start signal** 0x02 (1 Byte)

**Command** One of the predefined commands (1 Byte), the module implements new and modified commands in comparison to other radio compatible modules.

**Length** Specifies the number of payload data in the following field.

**Payload** Variable number (defined by the length field) of data or parameters.

**Checksum** Byte wise XOR combination of all preceding Bytes including the start signal, i.e.  
 $0x02 \wedge \text{Command} \wedge \text{Length} \wedge \text{Payload} = \text{CS}$



Host integration example codes for checksum calculation and command frame structure can be found in annex A and B, as well as in the *Wireless Connectivity SDK*.

All commands of type Request must obey the following rules:

- Only one request at a time may be active. Wait for confirmation of the previous request and implement a suiting timeout (depends on the command or action that was requested, 500 ms should cover the worst-case time).
- Indications are spontaneous messages, they may occur in between a command request and its confirmation.

- A high */RTS* line signalizes that the module UART is not ready for reception. Thus, any Byte(s) sent from the host will be discarded by the module without further user notification ("module busy"). If "module busy" occurs while sending a command to the module, it is necessary to resend this entire command again after */RTS* pin status shows "module idle" again.

## 7.2. Data transfer and reception in the command mode

This group of commands include the commands that either are used to request a radio telegram to be sent or indicates a received frame.

### 7.2.1. CMD\_DATA\_REQ

This command serves the simple data transfer in the command mode. Transmission takes place on the configured channel to the previously parametrised destination address (taken from the volatile runtime settings). This command is especially suitable for transmission for a point-to-point connection. The maximum number of payload data Bytes depends on the chosen RADIO\_DefaultRfProfile.

Format:

Start signal	Command	Length	Payload	CS
0x02	0x00	1 Byte	Length Bytes	1 Byte

Response (CMD\_DATA\_CNF):

Start signal	Command   0x40	Length	Status	CS
0x02	0x40	0x01	1 Byte	1 Byte

Status:

**0x00:** ACK received or not requested (MAC\_NumRetrys is 0, MAC\_DefaultAddressMode is 0 or a broadcast address is set as destination address)

**0x01:** no ACK received within a time-out after using all MAC\_NumRetrys

**0x03:** radio channel busy (LBT)

**0x04:** module is currently busy

**0xFF:** invalid (payload too long)

### 7.2.2. CMD\_DATAEX\_REQ

This command serves data transfer in a network with several parties. Both the RF channel to use and the destination address (depending on the parametrised address mode) are specified along with the command. The maximum number of payload data Bytes depends on the chosen RADIO\_DefaultRfProfile. The entered channel, destination network and destination address are loaded into the volatile runtime settings and thus are kept until the system is reset or these values are modified again.



Please note that the format of this command depends on the configured MAC\_DefaultAddressMode.

Address mode 0:

Start signal	Command	Length	Channel	Payload	CS
0x02	0x01	Payload len. + 1	1 Byte	Payload len. Bytes	1 Byte

Address mode 1:

Start signal	Command	Length	Channel	Dest. address	Payload	CS
0x02	0x01	Payload len. + 2	1 Byte	1 Byte	Payload len. Bytes	1 Byte

Address mode 2:

Start signal	Command	Length	Channel	Dest. netID	Dest. address	Payload	CS
0x02	0x01	Payload len. + 3	1 Byte	1 Byte	1 Byte	Payload len. Bytes	1 Byte

Address mode 3:

Start signal	Command	Length	Channel	Dest. netID	Dest. address	Payload	CS
0x02	0x01	Payload len. + 4	1 Byte	1 Byte	2 Byte (LSB first)	Payload len. Bytes	1 Byte

Response:

Start signal	CMD_DATA_REQ   0x40	Length	Status	CS
0x02	0x40	0x01	1 Byte	1 Byte

Status:

**0x00:** ACK received or not requested (MAC\_NumRetrys is 0, MAC\_DefaultAddressMode is 0 or a broadcast address is set as destination address)

**0x01:** no ACK received within a time-out after using all MAC\_NumRetrys

**0x02:** invalid channel selected

**0x03:** radio channel busy (LBT)

**0x04:** module is currently busy

**0xFF:** invalid (payload too long)

**7.2.3. CMD\_DATAEX\_IND**

This telegram indicates the reception of data Bytes and represents the counterpart to the commands CMD\_DATA\_REQ and CMD\_DATAEX\_REQ. Apart from the RX field strength (RSSI value given in two's complement notation), this telegram also displays the source address of the sending device (depending on the parametrised address mode).



Please note that the format of this command depends on the configured MAC\_DefaultAddressMode.

Format in address mode 0:

Start signal	Command	Length	Payload	Field strength	CS
0x02	0x81	Payload len. + 1	Payload len. Bytes	1 Byte	1 Byte

Format in address mode 1:

Start signal	Command	Length	Sender address	Payload	Field strength	CS
0x02	0x81	Payload len. + 2	1 Byte	Payload len. Bytes	1 Byte	1 Byte

Format in address mode 2:

Start signal	Command	Length	Sender network id	Sender address	Payload	Field strength	CS
0x02	0x81	Payload len. + 3	1 Byte	1 Byte	Payload len. Bytes	1 Byte	1 Byte

Format in address mode 3:

Start signal	Command	Length	Sender network id	Sender address	Payload	Field strength	CS
0x02	0x81	Payload len. + 4	1 Byte	2 Byte (LSB first)	Payload len. Bytes	1 Byte	1 Byte

**7.2.4. CMD\_REPEAT\_IND**

This command indicates that the module has repeated a data packet when acting in repeater mode. The source address and network id is the address of the origin sender of the RF packet, the destination address and network id is the address of the device that is supposed to receive the RF packet.

Format in address mode 0:

Start signal	Command	Length	Status	Address mode	CS
0x02	0x80	0x02	1 Byte	0x00	1 Byte

Format in address mode 1:

Start signal	Command	Length	Status	Address mode	Dest. address	Source address	CS
0x02	0x80	0x04	1 Byte	0x01	1 Byte	1 Byte	1 Byte

Format in address mode 2:

Start signal	Com.	Length	Status	Address. mode	Dest. NetID	Dest. address	Source NetID	Source address	CS
0x02	0x80	0x06	1 Byte	0x02	1 Byte	1 Byte	1 Byte	1 Byte	1 Byte

Format in address mode 3:

Start signal	Com.	Length	Status	Address. mode	Dest. NetID	Dest. address	Source NetID	Source address	CS
0x02	0x80	0x08	1 Byte	0x03	1 Byte	2 Byte (LSB first)	1 Byte	2 Byte (LSB first)	1 Byte

Status:

**0x00:** OK

**0x01:** Failed

**0x03:** radio channel busy (LBT)

**0x04:** module is currently busy



### 7.2.5. CMD\_DUTYCYCLE\_IND

This message indicates that the module has performed one or multiple radio sending actions (i.e. normal data tx, repeating of data and acknowledgements). The message contains the transmission time since the last CMD\_DUTYCYCLE\_IND message or the last module restart message (CMD\_RESET\_IND) in 1  $\mu$ s resolution. The 32 bit unsigned integer value is transmitted in LSB first notation. This information can be used to track the duty cycle.

Start signal	Command	Length	Time	CS
0x02	0x90	0x04	4 Bytes	1 Byte



This message has to be enabled using the user setting `CfgFlags`, by setting Bit1 to '1' (OR operation with 0x0002).

#### 7.2.5.1. Example

One or more Radio packets have been transmitted using a time of 0x00006C95 (27797<sub>dec</sub>)  $\mu$ s.

Start signal	Command	Length	Time	CS
0x02	0x90	0x04	0x95 0x6C 0x00 0x00	0x6F

### 7.3. Requesting parameters, actions and events

This group includes all commands that will return read-only parameters or request actions in the module.

#### 7.3.1. CMD\_RESET\_REQ

This command triggers a software reset of the module. The reset is performed after the acknowledgement is transmitted. All volatile settings are initialized with their defaults.

Format:

Start signal	Command	Length	CS
0x02	0x05	0x00	0x07

Response (CMD\_RESET\_CNF):

Start signal	Command   0x40	Length	Status	CS
0x02	0x45	0x01	1 Byte	1 Byte

Status:

**0x00:** Request successfully received and processed

**0x01:** Request not successful

As soon as the module has restarted a CMD\_RESET\_IND is printed on the UART and the /RTS line will show "module idle".

#### 7.3.2. CMD\_RESET\_IND

This message indicates that the module has restarted. After the /RTS line is low and the start-up time-out has passed, the module is ready to receive UART data and radio frames.

Start signal	Command	Length	Mode	CS
0x02	0x85	0x01	0x10	0x96

#### 7.3.3. CMD\_SHUTDOWN\_REQ

This command triggers the shut down mode of the chip, which is the mode with lowest power consumption. The shut down is performed after the command confirmation message is transmitted. The UART interface is disabled in shut down mode.

Format:

Start signal	Command	Length	CS
0x02	0x0E	0x00	0x0C

Response (CMD\_SHUTDOWN\_CNF):

Start signal	Command   0x40	Length	Status	CS
0x02	0x4E	0x01	1 Byte	1 Byte

Status:

**0x00:** Request successfully received and processed

**0x01:** Request not successful

To wake-up from shut down mode, a falling edge has to be applied to the *WAKE-UP* pin. In this case, the module restarts such that all volatile settings are lost. As soon as it has restarted a *CMD\_RESET\_IND* message is printed on the UART. Please note that in shut down mode, the *WAKE-UP* pin has an internal pull-down to ensure the wake-up is not performed accidentally due to a floating pin.

**7.3.4. CMD\_STANDBY\_REQ**

This command triggers the standby mode of the chip, a low power mode with RAM retention. The standby mode is entered after the command confirmation message is transmitted. The UART interface is disabled in standby mode. The latency is smaller than the latency caused by a complete restart of the module as done in the shut down mode.

Format:

Start signal	Command	Length	CS
0x02	0x0F	0x00	0x0D

Response (*CMD\_STANDBY\_CNF*):

Start signal	Command   0x40	Length	Status	CS
0x02	0x4F	0x01	1 Byte	1 Byte

Status:

**0x00:** Request successfully received and processed

**0x01:** Request not successful

To wake-up from standby mode, a falling edge has to be applied to the *WAKE-UP* pin. Please note that in standby mode, the *WAKE-UP* pin has an internal pull-down to ensure the wake-up is not performed accidentally due to a floating pin. When a falling edge is detected, the module wakes up but does not revert to factory settings as the RAM content is retained and all volatile settings are kept. Upon being idle again, a *CMD\_STANDBY\_IND* message is printed on the UART and the */RTS* pin will show a low level.

**7.3.5. CMD\_STANDBY\_IND**

This message indicates that the module woke up from standby mode and is ready for operation.

Start signal	Command   0x80	Length	Status	CS
0x02	0x8F	0x01	0x00	0x8C

Status:

**0x00:** wake-up successful

### 7.3.6. CMD\_RSSI\_REQ

This command returns the RX level of the last received packet determined by the transceiver IC in the form of a signed two's complement. The current RSSI value of the radio IC ("live RSSI value") cannot be requested by means of this command.



This function cannot be used to determine the live noise value on the radio channel.

Format:

Start signal	Command	Length	CS
0x02	0x0D	0x00	0x0F

Response (CMD\_RSSI\_CNF):

Start signal	Command   0x40	Length	RX level	CS
0x02	0x4D	0x01	1 Byte	1 Byte

The value obtained in this way delivers the RX level  $RSSI_{dBm}$  in dBm as follows.

Example: Conversion of the hexadecimal value in two's complement notation to a decimal  $RSSI_{dec}$

$$0xBD_{hex} = 10111101_{bin} \Rightarrow -128 + 0 \times 64 + 1 \times 32 + 1 \times 16 + 1 \times 8 + 1 \times 4 + 0 \times 2 + 1 \times 1 = -67dBm$$



If the RSSI equals 0x80 (-128dBm), there is no RSSI value available yet.

## 7.4. Modification of volatile parameters

This group contains all functions that will modify runtime settings while the module is running. These settings are volatile and will be reset to their defaults (see chapter 8) on a reset of the module or when waking up after a shut down command.

### 7.4.1. CMD\_SET\_PAPOWER\_REQ

This command is used to set the radio TX-power. Unlike the user settings parameter `RADIO_DefaultRfTXPower`, this is a volatile runtime parameter, but its power value is used in the same way. Thus, see section 8.2.3 for more information.



The parameters must be chosen carefully to reach good functionality and compliance with valid national regulatory requirements. The user of this module is solely responsible that the end device in which this product is designed in, adheres to all national applicable statutory regulations.

The power value is entered in the complement on two format.

Format:

Start signal	Command	Length	Power	CS
0x02	0x11	0x01	1 Byte	1 Byte

Response (`CMD_SET_PAPOWER_CNF`):

Start signal	Command   0x40	Length	Configured power	CS
0x02	0x51	0x01	1 Byte	1 Byte

#### 7.4.1.1. Example

Setting the power to +14 dBm:

Start signal	Command	Length	Configured power	CS
0x02	0x11	0x01	0x0E	0x1C

Response:

Start signal	Command   0x40	Length	Configured power	CS
0x02	0x51	0x01	0x0E	0x5C

### 7.4.2. CMD\_SET\_CHANNEL\_REQ

This command is used to select the radio channel. Unlike the user settings parameter `RADIO_DefaultRfChannel`, this is a volatile runtime parameter.



The parameters must be chosen carefully to reach good functionality and compliance with valid national regulatory requirements. The user of this module is solely responsible that the end device in which this product is designed in, adheres to all national applicable statutory regulations.

Format:

Start signal	Command	Length	Channel	CS
0x02	0x06	0x01	1 Byte	1 Byte

Response (CMD\_SET\_CHANNEL\_CNF):

Start signal	Command   0x40	Length	Configured channel	CS
0x02	0x46	0x01	1 Byte	1 Byte

### 7.4.2.1. Example

Selection of channel 226:

Start signal	Command	Length	channel	CS
0x02	0x06	0x01	0xE2	0xE7

Response:

Start signal	Command   0x40	Length	Configured channel	CS
0x02	0x46	0x01	0xE2	0xA7

### 7.4.3. CMD\_SET\_DESTNETID\_REQ

This command serves to configure the Dest. netID in address mode 2 and 3. Unlike the user settings parameter MAC\_DefaultDestNetID, this is a volatile runtime parameter.

Format:

Start signal	Command	Length	Dest. netID	CS
0x02	0x07	0x01	1 Byte	1 Byte

Return (CMD\_SET\_DESTNETID\_CNF):

Start signal	Command   0x40	Length	Status	CS
0x02	0x47	0x01	1 Byte	1 Byte

Status:

**0x00:** Request successfully received and processed

**0x01:** Request not successful

**7.4.4. CMD\_SET\_DESTADDR\_REQ**

This command serves to configure the destination address in address modes 1, 2 and 3. Unlike the user settings parameter MAC\_DefaultDestAddr, this is a volatile runtime parameter.

Format: Mode 1 + 2:

Start signal	Command	Length	Dest. address	CS
0x02	0x08	0x01 or 0x02	1 Byte or 2 Byte	1 Byte

Response (CMD\_SET\_DESTADDR\_CNF):

Start signal	Command   0x40	Length	Status	CS
0x02	0x48	0x01	1 Byte	1 Byte

Status:

**0x00:** Request successfully received and processed

**0x01:** Request not successful

**7.4.5. CMD\_SET\_MODE\_REQ**

This command triggers a change from command mode to transparent mode. The mode change is performed after the acknowledgement is transmitted.

Format:

Start signal	Command	Length	OpMode	CS
0x02	0x04	0x01	0x00	0x07

Response (CMD\_SET\_MODE\_CNF):

Start signal	Command   0x40	Length	Status	OpMode	CS
0x02	0x44	0x02	1 Byte	1 Byte	1 Byte

Status:

**0x00:** Request successfully received and processed

**0x01:** Request not successful

OpMode:

**0x00:** Transparent mode

**0x10:** Command mode

## 7.5. Modification of non-volatile parameters

The non-volatile parameters are also called user settings and are stored in a special flash location. These settings can also be configured using our Windows PC software "ACC".



The ACC software is available under request. For this, contact our technical support team under [WCS@we-online.com](mailto:WCS@we-online.com).

### 7.5.1. CMD\_SET\_REQ

This command enables direct manipulation of the parameters in the module's non-volatile user settings. The respective parameters are accessed by means of the corresponding SettingsIndex. Parameters with size of two or more Bytes have to be transferred with the LSB first unless otherwise specified.



The modified parameters only take effect after a restart of the module. This can be done by a `CMD_RESET_REQ` or using the `/RESET` pin.



The validity of the specified parameters is not verified by the application. Incorrect values can result in device malfunction up to a scenario where the firmware of the module needs to be re-flashed to get it operating again!



Any use of `CMD_SET_REQ` will consume one flash erase/write cycle. Flash erase/write cycles are limited through hardware (guaranteed minimum 100k cycles). For frequently changing parameters use the volatile parameters "Runtime settings", see chapter 7.4 .



To store the parameters in the flash memory of the module, the particular memory segment must be buffered into RAM, then to be erased entirely and then restored from RAM.

If a reset or VCC instability occurs during this procedure (e.g. due to supply voltage fluctuations), the entire memory area may be destroyed and the module can only be resurrected by means of a JTAG or Bootloader firmware update. Recommended procedure: First verify the configuration of the module with `CMD_GET_REQ` and only apply a `CMD_SET_REQ` if required. Make sure the VCC is stable and no reset occurs during this procedure.

Format:



Start signal	Command	Length	SettingsIndex	Parameter	CS
0x02	0x09	1 Byte	1 Byte	(Length - 1) Bytes	1 Byte

Response (CMD\_SET\_CNF):

Start signal	Command   0x40	Length	Status	CS
0x02	0x49	0x01	1 Byte	1 Byte

Status:

**0x00:** Request successfully received and processed

**0x01:** Operation failed due to invalid parameter

### 7.5.2. CMD\_GET\_REQ

This command can be used to query the user settings parameters. The respective parameters are accessed by means of the corresponding SettingsIndex.



Parameters with size of two or more Bytes will be transmitted LSB first unless noted otherwise.

Format:

Start signal	Command	Length	SettingsIndex	CS
0x02	0x0A	0x01	1 Byte	1 Byte

Response (CMD\_GET\_CNF):

Start signal	Command   0x40	Length	Status	Parameter	CS
0x02	0x4A	1 Byte	1 Byte	(Length - 1) Bytes	1 Byte

Status:

**0x00:** Request successfully received and processed

**0x01:** Request not successful

### 7.5.3. CMD\_FACTORY\_RESET\_REQ

This command restores the default user settings of the module. If this was successful, a software reset of the module is performed in addition.

Format:

Start signal	Command	Length	CS
0x02	0x12	0x00	0x10

Response (CMD\_FACTORY\_RESET\_CNF):

Start signal	Command   0x40	Length	Status	CS
0x02	0x52	0x01	1 Byte	1 Byte

Status:

**0x00:** Request successfully received and processed

**0x01:** Request not successful

## 7.6. Message overview

CMD	Message name	Short description	Chapter
0x00	CMD_DATA_REQ	Send data to configured address	7.2.1
0x01	CMD_DATAEX_REQ	Send data to specific address	7.2.2
0x04	CMD_SET_MODE_REQ	Switch operating mode	7.4.5
0x05	CMD_RESET_REQ	Reset module	7.3.1
0x06	CMD_SET_CHANNEL_REQ	Change the RF channel	7.4.2
0x07	CMD_SET_DESTNETID_REQ	Set the destination network id	7.4.3
0x08	CMD_SET_DESTADDR_REQ	Set the destination address	7.4.4
0x09	CMD_SET_REQ	Change the user settings	7.5.1
0x0A	CMD_GET_REQ	Read the user settings	7.5.2
0x0D	CMD_RSSI_REQ	Request RSSI of last packet	7.3.6
0x0E	CMD_SHUTDOWN_REQ	Go to shut down mode	7.3.3
0x0F	CMD_STANDBY_REQ	Go to standby mode	7.3.4
0x11	CMD_SET_PAPOWER_REQ	Change the radio TX power	7.4.1
0x12	CMD_FACTORY_RESET_REQ	Perform a factory reset	7.5.3
0x40	CMD_DATA_CNF	Data has been sent	7.2.1
0x45	CMD_RESET_CNF	Reset request received	7.3.1
0x46	CMD_SET_CHANNEL_CNF	Channel has been updated	7.4.2
0x47	CMD_SET_DESTNETID_CNF	Destination network id has been updated	7.4.3
0x48	CMD_SET_DESTADDR_CNF	Destination address has been updated	7.4.4
0x49	CMD_SET_CNF	User settings have been updated	7.5.1
0x4A	CMD_GET_CNF	Return the requested user setting values	7.5.2
0x4D	CMD_RSSI_CNF	Return the requested RSSI value	7.3.6
0x4E	CMD_SHUTDOWN_CNF	Shut down request received	7.3.3
0x4F	CMD_STANDBY_CNF	Standby request received	7.3.4
0x51	CMD_SET_PAPOWER_CNF	RF TX power has been updated	7.4.1
0x52	CMD_FACTORY_RESET_CNF	Factory reset request received	7.5.3
0x80	CMD_REPEAT_IND	Data has been repeated	7.2.4
0x81	CMD_DATAEX_IND	Data has been received	7.2.3
0x85	CMD_RESET_IND	Reset has been applied	7.3.2
0x8F	CMD_STANDBY_IND	Woke up from standby mode	7.3.5
0x90	CMD_DUTYCYCLE_IND	Radio packet has been transmitted	7.2.5

Table 10: Message overview

## 8. User settings - Module configuration values

### 8.1. Difference between volatile and non-volatile settings

The so-called user settings are stored permanently into the internal flash of the module. At start-up, these user settings are loaded as start values into the volatile settings ("Runtime settings"). Some of the runtime settings can be modified by special commands (see chapter 7.4). These runtime settings are lost and replaced by the user settings content when the module is restarted.



See chapters 7.4 and 7.5 for methods to change volatile and/or non-volatile settings.

The non-volatile user settings can be modified by means of specific commands in the configuration mode (CMD\_SET\_REQ) of the module. These parameters are stored permanently in the module's flash memory. All settings are described on the following pages. After changing those parameters, a reset will be necessary to make use of the new settings.



The validity of the specified parameters given with a CMD\_SET\_REQ is not verified. Incorrect values can result in device malfunction and may even result in the need of re-flashing the entire module firmware!

### 8.2. Modifying the user settings

The following chapters will give examples for the modification of many parameters using the commands CMD\_SET\_REQ and CMD\_GET\_REQ. The PC software ACC (AMBER Config Center, version 3.4.3 or newer) can also be used to change non-volatile parameters.

#### 8.2.1. UART\_Baudrate: Configure the UART speed

Settings index	Designation	Permissible values	Default value	Permissions	Number of Bytes
0	UART_Baudrate	9600 - 921600	115200	read/write	4

The user setting UART\_Baudrate is a 32 bit field that contains the symbol rate for the communication interface. The format for the parameter value is LSB first.



After changing the baud rate using the `CMD_SET_REQ`, the module restarts using the new baud rate. Thus, do not forget to update the baud rate of the connected host controller to be able to use the module's UART further on.



Since the UART baud rate is derived from the peripheral lock using a prescaler, errors to the exactly selected baud rate are to be expected. This variation gets worse the higher the selected baud rate is.



Double check the byte-order of the parameter. It is to be used `LSB first`. Wrong values may lead to a condition where talking with the module is not possible anymore.

**8.2.1.1. Example 1**

Set the baud rate of the module to 9600 Baud (`0x00002580MSBfirst` corresponds to `0x80250000LSBfirst`) using the `CMD_SET_REQ` with Settings index 0:

Start signal	Command	Length	Settings index	Parameter	CS
0x02	0x09	0x05	0x00	0x80 0x25 0x00 0x00	0xAB

Response `CMD_SET_CNF`: Successfully modified the setting.

Start signal	Command   0x40	Length	Status	CS
0x02	0x49	0x01	0x00	0x4A

**8.2.1.2. Example 2**

Request the baud rate of the module using `CMD_GET_REQ`:

Start signal	Command	Length	Settings index	CS
0x02	0x0A	0x01	0x00	0x09

Response `CMD_GET_CNF`: Successfully read out the baud rate 0x00002580 (9600 Baud).

Start signal	Command   0x40	Length	Status	Parameter	CS
0x02	0x4A	0x05	0x00	0x80 0x25 0x00 0x00	0xE8

**8.2.2. RADIO\_DefaultRfProfile: Configure the RF-settings**

Settings index	Designation	Permissible values	Default value	Permissions	Number of Bytes
1	RADIO_DefaultRfProfile	6	6	read/write	1

The user setting RADIO\_DefaultRfProfile is an 8 Bit field that addresses the applied RF configuration.



The parameter must be chosen with prudence to reach good functionality and compliance with valid regulatory requirements as the FCC in the United States of America.



After modification of the RADIO\_DefaultRfProfile, please check whether the RADIO\_DefaultRfChannel has to be updated too.

Radio profile	Data rate (gross) [kcps]	Modulation	Max packet size [byte]	Max packet time for repeater mode [ms]
6	400	GFSK	224	10

Table 11: Radio profiles

**8.2.2.1. Example 1**

Set the radio profile to 6 using the CMD\_SET\_REQ:

Start signal	Command	Length	Settings index	Parameter	CS
0x02	0x09	0x02	0x01	0x06	0x0E

Response CMD\_SET\_CNF: Successfully modified the setting.

Start signal	Command	Length	Status	CS
0x02	0x49	0x01	0x00	0x4A

**8.2.2.2. Example 2**

Request the radio profile using CMD\_GET\_REQ:

Start signal	Command	Length	Settings index	CS
0x02	0x0A	0x01	0x01	0x08

Response CMD\_GET\_CNF: Successfully read out the radio as 6.

Start signal	Command   0x40	Length	Status	Parameter	CS
0x02	0x4A	0x02	0x00	0x06	0x4C

**8.2.3. RADIO\_DefaultRfTXPower: Configure the RF TX-power**

Settings index	Designation	Permissible values	Default value	Permissions	Number of Bytes
2	RADIO_DefaultRfTXPower	0 - 14	14	read/write	1

This user setting defines the radio output power of the module. The user settings parameter RADIO\_DefaultRfTXPower is entered as a complement on two. This value represents the power at the radio ic without taking the antenna into account.



The user is responsible for adhering to the statutory regulations for the maximum power output when using this module. In case of the Telesto-III with an external antenna the antenna gain needs to be taken into account, too.

**8.2.3.1. Example 1**

Set the radio output power to 0 using the CMD\_SET\_REQ:

Start signal	Command	Length	Settings index	Parameter	CS
0x02	0x09	0x02	0x02	0x00	0x0B

Response CMD\_SET\_CNF: Successfully modified the setting.

Start signal	Command   0x40	Length	Status	CS
0x02	0x49	0x01	0x00	0x4A

**8.2.3.2. Example 2**

Request the radio output power using CMD\_GET\_REQ:

Start signal	Command	Length	Settings index	CS
0x02	0x0A	0x01	0x02	0x0B

Response CMD\_GET\_CNF: Successfully read out the radio as 0 dBm.

Start signal	Command   0x40	Length	Status	Parameter	CS
0x02	0x4A	0x02	0x00	0x00	0x48



**8.2.4. RADIO\_DefaultRfChannel: Configure the RF channel**

Settings index	Designation	Permissible values	Default value	Permissions	Number of Bytes
3	RADIO_DefaultRfChannel	201 - 251	226	read/write	1

This user setting determines the wireless channel of the module to be used after a reset. The dependence between channel and frequency is as follows:

$$Channel_{RF} = \frac{Frequency_{RF} - 802 MHz}{0.5 MHz} \tag{1}$$

or

$$Frequency_{RF} = 802 MHz + Channel_{RF} \times 0.5 MHz \tag{2}$$

Check chapter 10.1 for more information.



The user is responsible for adhering to the statutory regulations for the frequency and spectrum use when using this module.

**8.2.4.1. Example 1**

Set the radio channel to 201 (0xC9) using the CMD\_SET\_REQ:

Start signal	Command	Length	Settings index	Parameter	CS
0x02	0x09	0x02	0x03	0xC9	0xC3

Response CMD\_SET\_CNF: Successfully modified the setting.

Start signal	Command   0x40	Length	Status	CS
0x02	0x49	0x01	0x00	0x4A

**8.2.4.2. Example 2**

Request the radio channel using CMD\_GET\_REQ:

Start signal	Command	Length	Settings index	CS
0x02	0x0A	0x01	0x03	0x0A

Response CMD\_GET\_CNF: Successfully read out the radio as 226 (0xE2).

Start signal	Command   0x40	Length	Status	Parameter	CS
0x02	0x4A	0x02	0x00	0xE2	0xA8

**8.2.5. MAC\_DefaultAddressMode: Configure the address mode**

Settings index	Designation	Permissible values	Default value	Permissions	Number of Bytes
4	MAC_DefaultAddressMode	0 - 3	0	read/write	1

This setting defines the address mode of the module. The following modes have been implemented:

**No addressing (mode 0):** Each module receives the transmitted RF telegram and delivers the received data to the host system via UART. No address information is transmitted in the radio telegram.

**1-byte address (mode 1):** The receiving module only delivers the data to the host system via UART,

- if the 1 Byte destination address configured at the sender corresponds to the 1 Byte source address of the receiver (MAC\_SourceAddr) or
- if the destination broadcast address 255 was specified.

Both, the destination address and the source address are transmitted in the wireless telegram (total = 2 Bytes).

**2-Bytes address (mode 2):** The receiving module only delivers the data to the host system via UART,

- if both the destination network id and the 1 Byte destination address configured at the sender correspond to the source addresses of the receiver (MAC\_SourceNetID and 1 Byte MAC\_SourceAddr) or
- if the destination broadcast address 255 and/or network broadcast id 255 was specified.

A total of 4 Bytes of address information are transmitted in the wireless telegram.

**3-Bytes address (mode 3):** The receiving module only delivers the data to the host system via UART,

- if both the destination network id and the 2 Byte destination address configured at the sender correspond to the source addresses (MAC\_SourceNetID and 2 Byte MAC\_SourceAddr) of the receiver or
- if the destination broadcast address 65535 and network broadcast id 255 was specified.

A total of 6 Bytes of address information are transmitted in the wireless telegram.



In address mode 0, the use of wireless acknowledgement will cause problems if several wireless modules are addressed simultaneously. Therefore, no ACK is requested when using address mode 0 or when having any broadcast address in the frame (destination net ID and/or destination address). The user shall also not set `MAC_NumRetrys`  $\neq$  0 in address mode 0.



In address mode 0, the double packet detection will ignore concurrently received packets with the same sequence number. It's advisable to use at least address mode 1 in networks with more than 2 members and to configure the sender's addresses uniquely across the network.



The receiver and transmitter modules must always operate in the same address mode! Otherwise, the receiver cannot interpret the received data packet, meaning that the packet will be discarded!

**8.2.5.1. Example 1**

Set the address mode to 2 using the `CMD_SET_REQ`:

Start signal	Command	Length	Settings index	Parameter	CS
0x02	0x09	0x02	0x04	0x02	0x0F

Response `CMD_SET_CNF`: Successfully modified the setting.

Start signal	Command   0x40	Length	Status	CS
0x02	0x49	0x01	0x00	0x4A

**8.2.5.2. Example 2**

Request the address mode using `CMD_GET_REQ`:

Start signal	Command	Length	Settings index	CS
0x02	0x0A	0x01	0x04	0x0D

Response `CMD_GET_CNF`: Successfully read out the address mode as 1.

Start signal	Command   0x40	Length	Status	Parameter	CS
0x02	0x4A	0x02	0x00	0x01	0x4B

**8.2.6. MAC\_NumRetrys: Configure the number of retries**

Settings index	Designation	Permissible values	Default value	Permissions	Number of Bytes
6	MAC_NumRetrys	0 - 255	0	read/write	1

This user setting determines the maximum number of wireless transmission retries. If this parameter is set to a value other than zero, the receiver module will automatically be prompted to send a wireless ACK.



Note that sending ACKs additionally increases the traffic and will have influence on the duty-cycle, which can be crucial for CE compliance.



This parameter shall only be enabled (i.e. set to another value other than 0) if the parameter address mode selects a value of 1, 2 or 3 and the customer has configured unique addresses for the entire network. A use of broadcast messages (destination network ID and/or destination address) is not allowed when MAC\_NumRetrys is set to any value not equal to 0.

**8.2.6.1. Example 1**

Set the transmission retry number to 1 using the CMD\_SET\_REQ:

Start signal	Command	Length	Settings index	Parameter	CS
0x02	0x09	0x02	0x06	0x01	0x0E

Response CMD\_SET\_CNF: Successfully modified the setting.

Start signal	Command	Length	Status	CS
0x02	0x49	0x01	0x00	0x4A

**8.2.6.2. Example 2**

Request the number of retries using CMD\_GET\_REQ:

Start signal	Command	Length	Settings index	CS
0x02	0x0A	0x01	0x06	0x0F

Response CMD\_GET\_CNF: Successfully read out the number of retries as 3.

Start signal	Command   0x40	Length	Status	Parameter	CS
0x02	0x4A	0x02	0x00	0x013	0x49

**8.2.7. MAC\_DefaultDestNetID: Configure the destination network ID**

Settings index	Designation	Permissible values	Default value	Permissions	Number of Bytes
7	MAC_DefaultDestNetID	0 - 255	255	read/write	1

This user setting specifies the default destination network ID, which is used in address modes 2 and 3. If the special broadcast ID and the broadcast address are set to 255, the packets will be received by all network participants. Its volatile runtime settings can be modified with the command CMD\_SET\_DESTNETID\_REQ at runtime.

**8.2.7.1. Example 1**

Set the default destination network ID to 1 using the CMD\_SET\_REQ:

Start signal	Command	Length	Settings index	Parameter	CS
0x02	0x09	0x02	0x07	0x01	0x0F

Response CMD\_SET\_CNF: Successfully modified the setting.

Start signal	Command   0x40	Length	Status	CS
0x02	0x49	0x01	0x00	0x4A

**8.2.7.2. Example 2**

Request the default destination network ID using CMD\_GET\_REQ:

Start signal	Command	Length	Settings index	CS
0x02	0x0A	0x01	0x07	0x0E

Response CMD\_GET\_CNF: Successfully read out the default destination network ID as 0.

Start signal	Command   0x40	Length	Status	Parameter	CS
0x02	0x4A	0x02	0x00	0x00	0x4A

**8.2.8. MAC\_DefaultDestAddr: Configure the destination address**

Settings index	Designation	Permissible values	Default value	Permissions	Number of Bytes
8	MAC_DefaultDestAddr	0 - 65535	65535	read/write	1-2

This user setting specifies destination address, which is used in address modes 1, 2 and 3. If a broadcast address (255 in address modes 1 and 2 or 65535 in address mode 3) is used, the packets will be received by all network participants or by participants in the same network ID. Its volatile runtime settings can be modified with the command `CMD_SET_DESTADDR_REQ` at runtime.

**8.2.8.1. Example 1**

Set the default destination address to 1 using the `CMD_SET_REQ`. If only one-byte parameter size is used, the LSB is set to the value of the parameter and the MSB is automatically written to 0xFF.

Start signal	Command	Length	Settings index	Parameter	CS
0x02	0x09	0x02	0x08	0x01	0x00

Response `CMD_SET_CNF`: Successfully modified the setting.

Start signal	Command   0x40	Length	Status	CS
0x02	0x49	0x01	0x00	0x4A

**8.2.8.2. Example 2**

Set the default destination address to 256 (0x0100) using the `CMD_SET_REQ`. LSB = 0x00, MSB = 0x01. The MSB of the address is used in address mode 3 only. The 2-byte parameter field has the order LSB first.

Start signal	Command	Length	Settings index	Parameter	CS
0x02	0x09	0x03	0x08	0x00 0x01	0x01

Response `CMD_SET_CNF`: Successfully modified the setting.

Start signal	Command   0x40	Length	Status	CS
0x02	0x49	0x01	0x00	0x4A

**8.2.8.3. Example 3**

Request the default destination address using `CMD_GET_REQ`:



Start signal	Command	Length	Settings index	CS
0x02	0x0A	0x01	0x08	0x01

Response CMD\_GET\_CNF: Successfully read out the default destination address as 0 (0x0000). The 2-byte parameter has the order LSB first. The return value of this settings index is always read as 2-byte parameter.

Start signal	Command   0x40	Length	Status	Parameter	CS
0x02	0x4A	0x03	0x00	0x00 0x00	0x4B

**8.2.9. MAC\_SourceNetID: Configure the source network ID**

Settings index	Designation	Permissible values	Default value	Permissions	Number of Bytes
10	MAC_SourceNetID	0 - 254	0	read/write	1

This user setting specifies the source network ID to be used in address modes 2 and 3. Setting the Source Net ID to Broadcast (255) is not allowed.

**8.2.9.1. Example 1**

Set the source network ID to 1 using the CMD\_SET\_REQ:

Start signal	Command	Length	Settings index	Parameter	CS
0x02	0x09	0x02	0x0A	0x01	0x02

Response CMD\_SET\_CNF: Successfully modified the setting.

Start signal	Command   0x40	Length	Status	CS
0x02	0x49	0x01	0x00	0x4A

**8.2.9.2. Example 2**

Request the source network ID using CMD\_GET\_REQ:

Start signal	Command	Length	Settings index	CS
0x02	0x0A	0x01	0x0A	0x03

Response CMD\_GET\_CNF: Successfully read out the source network ID as 2.

Start signal	Command   0x40	Length	Status	Parameter	CS
0x02	0x4A	0x02	0x00	0x02	0x48

**8.2.10. MAC\_SourceAddr: Configure the source address**

Settings index	Designation	Permissible values	Default value	Permissions	Number of Bytes
11	MAC_SourceAddr	0 - 65534	0	read/write	1-2

This user setting specifies the source device address to be used in address modes 1, 2 and 3. The LSB corresponds to the first byte in "parameter"; the MSB (if used) to the second byte. The broadcast address 0xFF (255) or 0xFFFF (65535) must not be used for the source address (LSB, LSB+MSB) and source network ID parameters.

**8.2.10.1. Example 1**

Set the source address to 1 (this will set the LSB to 0x01, the MSB is automatically set to 0xFF) using the CMD\_SET\_REQ:

Start signal	Command	Length	Settings index	Parameter	CS
0x02	0x09	0x02	0x0B	0x01	0x03

Response CMD\_SET\_CNF: Successfully modified the setting.

Start signal	Command   0x40	Length	Status	CS
0x02	0x49	0x01	0x00	0x4A

**8.2.10.2. Example 2**

Set the source address to 256 (LSB =0x00, MSB = 0x01) using the CMD\_SET\_REQ. The 2-byte parameter is to be used LSB first.

Start signal	Command	Length	Settings index	Parameter	CS
0x02	0x09	0x03	0x0B	0x00 0x01	0x02

Response CMD\_SET\_CNF: Successfully modified the setting.

Start signal	Command   0x40	Length	Status	CS
0x02	0x49	0x01	0x00	0x4A

**8.2.10.3. Example 3**

Request the source address using CMD\_GET\_REQ:

Start signal	Command	Length	Settings index	CS
0x02	0x0A	0x01	0x0B	0x02

Response CMD\_GET\_CNF: Successfully read out the source address as 2 (0x0002). The 2-byte parameter is to be used LSB first.

Start signal	Command   0x40	Length	Status	Parameter	CS
0x02	0x4A	0x03	0x00	0x02 0x00	0x49

**8.2.11. OpMode: Default operating mode of the module**

Settings index	Designation	Permissible values	Default value	Permissions	Number of Bytes
14	OpMode	0,16	16	read, write	1

The OpMode configures the operating mode of the module after start-up. A OpMode of 0x10 (16) represents the command mode. OpMode 0x00 indicates transparent mode.



The *MODE\_1* pin has a higher priority than OpMode. Therefore, if OpMode is configured as 0x10 (command mode) and *MODE\_1* pin has a HIGH level during start-up, the module will start in transparent mode.

**8.2.11.1. Example 1**

Set the operating mode to command mode (0x10) using the CMD\_SET\_REQ:

Start signal	Command	Length	Settings index	Parameter	CS
0x02	0x09	0x02	0x0E	0x10	0x17

Response CMD\_SET\_CNF: Successfully modified the setting.

Start signal	Command   0x40	Length	Status	CS
0x02	0x49	0x01	0x00	0x4A

**8.2.11.2. Example 2**

Request the operation mode using CMD\_GET\_REQ:

Start signal	Command	Length	Settings index	CS
0x02	0x0A	0x01	0x0E	0x07

Response CMD\_GET\_CNF: Successfully read out that the operation mode is command mode (0x10).

Start signal	Command   0x40	Length	Status	Parameter	CS
0x02	0x4A	0x02	0x00	0x10	0x5A

**8.2.12. OpMode\_Flags: Configure transmission trigger for transparent mode**

Settings index	Designation	Permissible values	Default value	Permissions	Number of Bytes
18	OpMode_Flags	See description	0x0C	read/write	1

Selects and configures the trigger to start the radio transmission for the transparent mode. Various triggers can be activated simultaneously. Only used in transparent mode.

Independent of the configuration of OpMode\_Flags, a radio transmission will be triggered whenever the maximum packet size is reached. The maximum packet size depends on RADIO\_DefaultRfProfile.

Bit no.	Filter	Description
0	0x01	Set this bit to '1' to include the ETX characters in the payload of the radio frame. Otherwise ETX characters will be removed before radio transmission. Only used when bit 1 is set to '1'.
1	0x02	Set this bit to '1' to enable ETX character as trigger for radio transmission. See UART_ETX_Character0 and UART_ETX_Character1 to configure ETX characters.
2	0x04	Set this bit to '1' to enable timeout as trigger for radio transmission. See UART_Timeout to configure timeout.
3	0x08	Set this bit to '1' to set length of ETX character to two bytes. Set this bit to '0' to set length to one byte. Only used when bit 1 is set to '1'.
4-7	0xF0	Reserved for future use. All reserved bits shall be set to '0'.

**8.2.12.1. Example 1**

Set the parameter OpMode\_Flags to 0x04, which means that the transmission starts when the maximum packet size or timeout has been reached.

Command:

Start signal	Command	Length	Settings index	Parameter	CS
0x02	0x09	0x02	0x12	0x04	0x1F

Response CMD\_SET\_CNF: Successfully modified the setting.

Start signal	Command	Length	Status	CS
0x02	0x49	0x01	0x00	0x4A

**8.2.12.2. Example 2**

Request the flags using CMD\_GET\_REQ:

Start signal	Command	Length	Settings index	CS
0x02	0x0A	0x01	0x12	0x1B

Response CMD\_GET\_CNF: Successfully read out the value of OpMode\_Flags. A value of 0x04 indicates timeout as trigger for radio transmissions.

Start signal	Command   0x40	Length	Status	Parameter	CS
0x02	0x4A	0x03	0x00	0x04	0x4F

**8.2.13. UART\_Timeout: Configure timeout for transparent mode**

Settings index	Designation	Permissible values	Default value	Permissions	Number of Bytes
21	UART_Timeout	5 - 255	5	read,write	1

UART\_Timeout is used when OpMode\_Flags is configured to use timeout as radio transmission trigger in transparent mode. If the module receives no new byte within the defined UART\_Timeout and the buffer is not empty, a radio transmission starts. UART\_Timeout is stated in milliseconds. UART\_Timeout is only used in transparent mode.

**8.2.13.1. Example 1**

Set the timeout to 5 ms using the CMD\_SET\_REQ:

Start signal	Command	Length	Settings index	Parameter	CS
0x02	0x09	0x02	0x15	0x05	0x19

Response CMD\_SET\_CNF: Successfully modified the setting.

Start signal	Command   0x40	Length	Status	CS
0x02	0x49	0x01	0x00	0x4A

**8.2.13.2. Example 2**

Request the timeout using CMD\_GET\_REQ:

Start signal	Command	Length	Settings index	CS
0x02	0x0A	0x01	0x15	0x1C

Response CMD\_GET\_CNF: Successfully read out the timeout of 5 ms.

Start signal	Command   0x40	Length	Status	Parameter	CS
0x02	0x4A	0x02	0x00	0x05	0x4F



**8.2.14. UART\_ETX\_Character0: Configure ETX characters for transparent mode**

Settings index	Designation	Permissible values	Default value	Permissions	Number of Bytes
19	UART_ETX_Character0	See description	0x0D	read/write	1 or 2

UART\_ETX\_Character0 is used when OpMode\_Flags is configured to use ETX characters as radio transmission trigger in transparent mode. If the module receives the defined ETX\_Characters within the received data over UART and the buffer is not empty, a radio transmission starts. When using a parameter length of 2, UART\_ETX\_Character0 and UART\_ETX\_Character1 can be set simultaneously (see example 2 below). However, the parameters have to be read out separately.

UART\_ETX\_Character0 is only used in transparent mode.

**8.2.14.1. Example 1**

Set the parameter UART\_ETX\_Character0 to 0x0D using CMD\_SET\_REQ.

Command:

Start signal	Command	Length	Settings index	Parameter	CS
0x02	0x09	0x02	0x13	0x0D	0x17

Response CMD\_SET\_CNF: Successfully modified the setting.

Start signal	Command   0x40	Length	Status	CS
0x02	0x49	0x01	0x00	0x4A

**8.2.14.2. Example 2**

Set the parameter UART\_ETX\_Character0 to 0x0D and UART\_ETX\_Character1 to 0x0A using CMD\_SET\_REQ.

Command:

Start signal	Command	Length	Settings index	Parameter	CS
0x02	0x09	0x03	0x13	0x0D 0x0A	0x1C

Response CMD\_SET\_CNF: Successfully modified the setting.

Start signal	Command   0x40	Length	Status	CS
0x02	0x49	0x01	0x00	0x4A

**8.2.14.3. Example 3**

Request the ETX-character using CMD\_GET\_REQ:

Start signal	Command	Length	Settings index	CS
0x02	0x0A	0x01	0x13	0x1A

Response CMD\_GET\_CNF: Successfully read out the value of UART\_ETX\_Character0.

Start signal	Command   0x40	Length	Status	Parameter	CS
0x02	0x4A	0x03	0x00	0x0D	0x46

**8.2.15. UART\_ETX\_Character1: Configure ETX character for transparent mode**

Settings index	Designation	Permissible values	Default value	Permissions	Number of Bytes
20	UART_ETX_Character1	See description	0x0A	read/write	1

UART\_ETX\_Character1 is used when OpMode\_Flags is configured to use two ETX-characters as radio transmission trigger in transparent mode. If the module receives the defined ETX characters within the received data over UART and the buffer is not empty, a radio transmission starts. UART\_ETX\_Character1 is only used in transparent mode.

**8.2.15.1. Example 1**

Set the parameter UART\_ETX\_Character1 to 0x0A using CMD\_SET\_REQ.

Command:

Start signal	Command	Length	Settings index	Parameter	CS
0x02	0x09	0x02	0x14	0x0A	0x17

Response CMD\_SET\_CNF: Successfully modified the setting.

Start signal	Command   0x40	Length	Status	CS
0x02	0x49	0x01	0x00	0x4A

**8.2.15.2. Example 2**

Request the ETX-character using CMD\_GET\_REQ:

Start signal	Command	Length	Settings index	CS
0x02	0x0A	0x01	0x14	0x1D

Response CMD\_GET\_CNF: Successfully read out the value of UART\_ETX\_Character1.

Start signal	Command   0x40	Length	Status	Parameter	CS
0x02	0x4A	0x02	0x00	0x0A	0x40

**8.2.16. CfgFlags: Configure the configuration flags of the module**

Settings index	Designation	Permissible values	Default value	Permissions	Number of Bytes
15	CfgFlags	See description	0	read/write	2

This parameter is used for the general module configuration.



Repeater and sniffer mode cannot be enabled at the same time. A module configured as sniffer will not send any ACKs, even if requested by the sender.

Bit no.	Filter	Description
0	0x0001	Set this bit to '1' to enable the sniffer mode. The sniffer mode will ignore all destination addresses in the radio frames and forward any compatible message into a CMD_DATAEX_IND. Not to be used when repeater mode is enabled or MAC_NumRetrys is not equal to 0.
1	0x0002	Set this bit to '1' to enable the duty cycle tracker mode. In this mode CMD_DUTYCYCLE_IND messages are output by the module, when the module transmitted data on the radio. This message contains the time needed to transmit the radio data, which can be used by the host to track its duty cycle.
2 - 15	0xFFFC	Reserved for future use. All reserved bits '0'.

**8.2.16.1. Example 1**

Enable the sniffer mode by setting the CfgFlags parameter value to 0x0001 using the CMD\_SET\_REQ. The 2-byte parameter is to be used LSB first.

Start signal	Command	Length	Settings index	Parameter	CS
0x02	0x09	0x03	0x0F	0x01 0x00	0x06

Response CMD\_SET\_CNF: Successfully modified the setting.

Start signal	Command   0x40	Length	Status	CS
0x02	0x49	0x01	0x00	0x4A

**8.2.16.2. Example 2**

Request the configuration flags using CMD\_GET\_REQ:

Start signal	Command	Length	Settings index	CS
0x02	0x0A	0x01	0x0F	0x06

Response CMD\_GET\_CNF: Successfully read out the value of CfgFlags. The 2-byte parameter is to be used LSB first. A parameter value 0x0000 indicates that the sniffer mode is disabled.

Start signal	Command   0x40	Length	Status	Parameter	CS
0x02	0x4A	0x03	0x00	0x00 0x00	0x4B

**8.2.17. RpFlags: Configure the repeater flags of the module**

Settings index	Designation	Permissible values	Default value	Permissions	Number of Bytes
16	RpFlags	See description	0	read/write	2

This parameter is used for the repeater configuration. See chapter 13 for more information about the repeater mode.



Repeater and sniffer mode cannot be enabled at the same time.



The repeater function shall not be enabled in radio profile 4.



The user is responsible for adhering to the statutory regulations for the frequency and spectrum use when using the repeater mode with this module. Especially the duty-cycle of each repeating network node must be checked and controlled by the end system application in respect to country-specific regulations.

Bit no.	Filter	Description
0	0x0001	Set this bit to '1' to enable the repeater mode.
1 - 15	0xFFFE	Reserved for future use. All reserved bits '0'.

**8.2.17.1. Example 1**

Enable the repeater mode by setting the RpFlags parameter value to 0x0001 using the CMD\_SET\_REQ. The 2-byte parameter is to be used LSB first.

Start signal	Command	Length	Settings index	Parameter	CS
0x02	0x09	0x03	0x10	0x01 0x00	0x19

Response CMD\_SET\_CNF: Successfully modified the setting.

Start signal	Command   0x40	Length	Status	CS
0x02	0x49	0x01	0x00	0x4A

**8.2.17.2. Example 2**

Request the repeater flags using CMD\_GET\_REQ:

Start signal	Command	Length	Settings index	CS
0x02	0x0A	0x01	0x10	0x19

Response CMD\_GET\_CNF: Successfully read out the value of RpFlags. The 2-byte parameter is to be used LSB first. A parameter value 0x0000 indicates that the repeater mode is disabled. A value of 0x0001 indicates that the repeater mode is enabled.

Start signal	Command   0x40	Length	Status	Parameter	CS
0x02	0x4A	0x03	0x00	0x00 0x00	0x4B

**8.2.18. RP\_NumSlots: Configure the repeater data base**

Settings index	Designation	Permissible values	Default value	Permissions	Number of Bytes
17	RP_NumSlots	1 -255	32	read/write	1

An 8 bit field that contains the number of time slots to be used for the packet repetition. When using several repeater devices in a single network, repeated data packets may collide on the frequency channel, when all repeater devices send the received packet at the same time. To avoid this, the frequency channel is divided in RP\_NumSlots time slots, where each repeater chooses a certain slot randomly.



Repeaters must be carefully positioned within a network setup, in order to prevent loops and additional latency. It is not an intended use of this product to enable repeater mode on any or, worst case, all devices in the network.

The smallest number of time slots that is needed depends on the network structure and the number of the repeaters used. Assume there are NumRP repeater devices in the range of a sending device. The probability that two repeated packets collide can be calculated by:

$$1 - \frac{RP\_NumSlots!}{RP\_NumSlots^{NumRP} \times (RP\_NumSlots - NumRP)!} \tag{3}$$

Common values are:

NumRP	RP_NumSlots	Collision probability
2	32	3.1%
3	32	9.2%
4	32	17.7%
5	64	14.8%
6	64	21.5%
7	128	15.4%

In the example network shown in figure 7, there are only two repeaters that can conflict with each other. Repeater 2 and 3 are forwarding the packet received from sender 1 "at the same time". Thus, NumRP equals 2 and RP\_NumSlots equal 32 is sufficient to have a collision probability of less than 5%. The time delay used by the repeater device can be determined as the time needed to send one packet (see table 11) times a random number between one and RP\_NumSlots.

Example:

In RADIO\_DefaultRfProfile 0 the maximum send time for one packet is about 40 ms. If we use 32 RP\_NumSlots, the packet is forwarded latest after 32×40 ms=1280 ms.



**8.2.18.1. Example 1**

Set the RP\_NumSlots to 64 (0x40) using the CMD\_SET\_REQ.

Start signal	Command	Length	Settings index	Parameter	CS
0x02	0x09	0x02	0x11	0x40	0x58

Response CMD\_SET\_CNF: Successfully modified the setting.

Start signal	Command   0x40	Length	Status	CS
0x02	0x49	0x01	0x00	0x4A

**8.2.18.2. Example 2**

Request the number of repeater slots using CMD\_GET\_REQ:

Start signal	Command	Length	Settings index	CS
0x02	0x0A	0x01	0x11	0x18

Response CMD\_GET\_CNF: Successfully read out the number of repeater slots as 32 (0x20).

Start signal	Command   0x40	Length	Status	Parameter	CS
0x02	0x4A	0x02	0x00	0x20	0x6A

**8.2.19. LBT\_ObservationPeriod: Configure the observation period for LBT**

Settings index	Designation	Permissible values	Default value	Permissions	Number of Bytes
26	LBT_ObservationPeriod	0 - 15	0	read/write	1

The LBT\_ObservationPeriod defines the duration to listen on the channel, to determine if it is busy or free. If it is set to 0, then LBT is disabled. Otherwise, it is enabled with the specified observation period. LBT\_ObservationPeriod is stated in milliseconds.



Activating LBT will reduce the throughput of the network, depending on the selected observation period.

**8.2.19.1. Example 1**

Set LBT\_ObservationPeriod to 15 (0x0F) using the CMD\_SET\_REQ.

Start signal	Command	Length	Settings index	Parameter	CS
0x02	0x09	0x02	0x1A	0x0F	0x1C

Response CMD\_SET\_CNF: Successfully modified the setting.

Start signal	Command   0x40	Length	Status	CS
0x02	0x49	0x01	0x00	0x4A

**8.2.19.2. Example 2**

Request LBT\_ObservationPeriod using CMD\_GET\_REQ:

Start signal	Command	Length	Settings index	CS
0x02	0x0A	0x01	0x1A	0x13

Response CMD\_GET\_CNF: Successfully read out the observation period for LBT as 14 (0x0E) ms.

Start signal	Command   0x40	Length	Status	Parameter	CS
0x02	0x4A	0x02	0x00	0x0E	0x44

**8.2.20. LBT\_Threshold: Configure the RSSI threshold for LBT**

Settings index	Designation	Permissible values	Default value	Permissions	Number of Bytes
27	LBT_Threshold	-100 - -45	-80 (0xB0)	read/write	1

LBT\_Threshold defines the minimum RSSI value during LBT\_ObservationPeriod to consider the channel to be busy. LBT\_Threshold is stated in dBm.



LBT\_Threshold is only used when LBT is enabled (LBT\_ObservationPeriod is set to a value other than 0).  
Since this value is negative, it is expressed in two's complement.

**8.2.20.1. Example 1**

Set LBT\_Threshold to -60 (0xC4) dBm using the CMD\_SET\_REQ.

Start signal	Command	Length	Settings index	Parameter	CS
0x02	0x09	0x02	0x1B	0xC4	0xD6

Response CMD\_SET\_CNF: Successfully modified the setting.

Start signal	Command   0x40	Length	Status	CS
0x02	0x49	0x01	0x00	0x4A

**8.2.20.2. Example 2**

Request LBT\_Threshold using CMD\_GET\_REQ:

Start signal	Command	Length	Settings index	CS
0x02	0x0A	0x01	0x1B	0x12

Response CMD\_GET\_CNF: Successfully read out the threshold for LBT as -95 (0xA1) dBm.

Start signal	Command   0x40	Length	Status	Parameter	CS
0x02	0x4A	0x02	0x00	0xA1	0xEB

**8.2.21. FactorySettings: Read out the factory settings**

Settings index	Designation	Permissible values	Default value	Permissions	Number of Bytes
32	FactorySettings	-	-	read	8

This parameter defines the factory settings of the module.

byte no.	Description
3 : 0	Serial number: 3 byte ID (LSB first), 1 byte PID
6 : 4	Hardware version: Major , Minor, Patch
7	Frequency correction factor

**8.2.21.1. Example 1**

Request the factory settings of the module using CMD\_GET\_REQ:

Start signal	Command	Length	Settings index	CS
0x02	0x0A	0x01	0x20	0x29

Response CMD\_GET\_CNF: Successfully read out the FactorySettings.

Start signal	Command   0x40	Length	Status	Parameter	CS
0x02	0x4A	0x09	0x00	0x01 0x00 0x00 0x74 0x00 0x03 0x02 0x00	0x35

Successfully returned the following factory settings, the order of the multi byte parameters was changed to MSB first to be converted into decimal numbers later:

- Serial number: 0x74.000001 (116.000001) with PID 0x74 (116) and SN 0x000001 (1)
- Hardware version 0x02 0x03 0x00 (2.3.0)
- Frequency correction factor of 0x00 (0)

**8.2.22. FirmwareVersion: Read out the firmware version**

Settings index	Designation	Permissible values	Default value	Permissions	Number of Bytes
33	FirmwareVersion	-	-	read	3

This parameter defines the version of the firmware currently running on the module.

**8.2.22.1. Example 1**

Request the factory settings of the module using `CMD_GET_REQ`:

Start signal	Command	Length	Settings index	CS
0x02	0x0A	0x01	0x21	0x28

Response `CMD_GET_CNF`: Successfully read out the firmware version as 2.1.0. The sequence inside the field "Parameter" is patch, minor, major.

Start signal	Command   0x40	Length	Status	Parameter	CS
0x02	0x4A	0x04	0x00	0x00 0x01 0x02	0x4F

## 9. Timing parameters

### 9.1. Reset behavior

Following a reset, a `CMD_RESET_IND` and a stable low level on the `/RTS` pin signalizes that the module is ready for operation. During restart, the `/RTS` may be pulled to GND level for a short time ( $< 100 \mu\text{s}$ , see figure 5) until it is configured accordingly by the application on the module.

#### 9.1.1. Reset via `/RESET` pin

To force a module restart by means of the `/RESET` pin, it must first be drawn to low for at least 1 ms. After the pin is released, the module will reboot, indicate a `CMD_RESET_IND`.



Note that the selected UART baud rate will introduce a latency for transmitting the 5-byte packet at module start-up.

Recommended procedure: After the `/RESET` pin is released, wait for up to 200 ms + UART transmission time for the `CMD_RESET_IND` packet (value is to be adopted for the selected UART baud rate) and for the stable low level on the `/RTS` pin.



This section applies only to a situation where the VDD is stable and the module was already running. Additional timings are needed when VDD was just applied to the module. See chapter 4.2

#### 9.1.2. Reset as result of a serious error condition

If the module runs into a serious error condition, a software reset will be executed. In this case, the module starts up (this includes sending a `CMD_RESET_IND`) automatically and can then be used again. The volatile runtime settings are reset to default values. Therefore, the host needs to detect the start-up indication and implement/reconfigure the module's volatile settings, if this event was detected.

## 9.2. Latencies when leaving standby or shutdown

The indication `CMD_RESET_IND` or `CMD_STANDBY_IND` (5 Bytes in total) are written before the `/RTS` pin is pulled back to low level. Therefore, the start-up time is also dependent on the UART baud rate. The time presented here was measured with the UART default setting of 115200 Baud, 8n1.

### 9.2.1. Wake-up latency from standby

The wake-up time from standby is 1.6 ms.

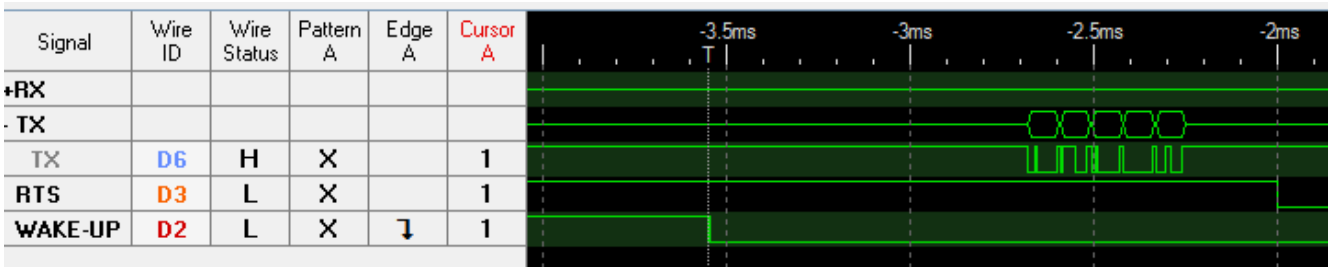

Figure 5: Wake-up from standby

**9.2.2. Wake-up latency from shutdown**

The wake-up time from shutdown is 5 ms.

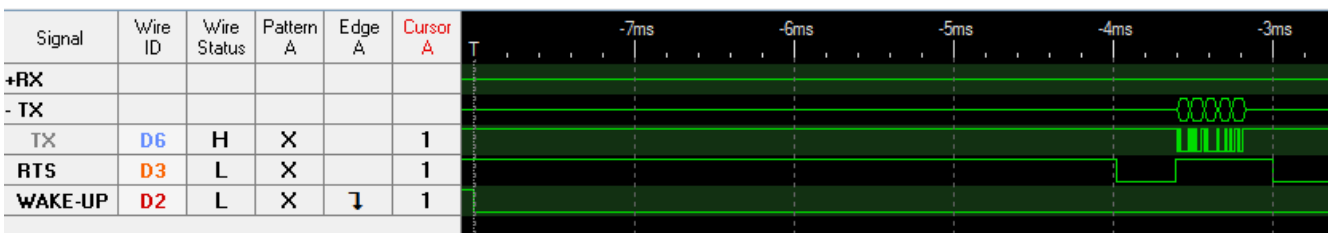

Figure 6: Wake-up from shutdown

**9.3. Latencies during data transfer / packet generation**

The data transfer is always buffered, i.e. data received via UART is buffered in the module until a specific event occurs (i.e. packet completed with the CS field of a command). Subsequently, the UART reception is interrupted (flow control with /RTS signal) and the payload data is passed to the internal memory of the wireless transceiver (FIFO).

By using several UART buffers, the time during which the UART is not receiving can be minimized.

The wireless transmission starts as soon as the first complete data packet is available in the transceiver memory. During the continuous wireless transmission, the remaining payload data is transmitted byte by byte on the radio. On the receiver side, the buffer is read as soon as an incoming packet is detected. The entire radio frame is buffered in the radio buffer and processed once the frame was checked against bit errors.

If the module detects a packet that requires an ACK, the ACK is sent directly after the full packet reception. The channel access method is always deactivated for any ACKs.

## 10. Radio parameters

The default radio parameters are determined by the values of `RADIO_DefaultRfProfile`, `RADIO_DefaultRfChannel` and `RADIO_DefaultRfTXPower` in the user settings. These non-volatile parameters can be modified using `CMD_SET_REQ`. To modify their volatile counterparts the commands `CMD_SET_PAPOWER_REQ` and `CMD_SET_CHANNEL_REQ` can be used.



The parameters must be chosen with prudence not only to ensure optimal functionality, but also in compliance to the appropriate regulatory requirements such as the FCC in the United States of America.

The module (both the PCB antenna and the external antenna versions) is pre-certified by mounting it on its EV-board. However, conformance of the end-device to this certification depends on the radiated power. Among other factors, the radiated power depends on the selected antenna, the wiring to the antenna and the quality of the power supply. Thus, it is highly recommended that the end-device manufacturer verify the radiated power on the end application. The frequency channels of the module can be selected from a 500 kHz grid.

### 10.1. Channel assignment

**A** means that the channel is allowed corresponding to the appropriate operational frequency band requirements.

- means, that the channel is not allowed and is blocked by the firmware.

\* means, that the channel in general is allowed, we recommend to use every second channel as the 6dB bandwidth is 500 kHz to fulfill FCC § 15.247 (a)(2).



Channel	Frequency [MHz]	Profile 6		Channel	Frequency [MHz]	Profile 6	
		Proposed channel grid 1	Proposed channel grid 2			Proposed channel grid 1	Proposed channel grid 2
200	902	-	-	227	915.5	*	A
201	902.5	*	A	228	916	A	*
202	903	A	*	229	916.5	*	A
203	903.5	*	A	230	917	A	*
204	904	A	*	231	917.5	*	A
205	904.5	*	A	232	918	A	*
206	905	A	*	233	918.5	*	A
207	905.5	*	A	234	919	A	*
208	906	A	*	235	919.5	*	A
209	906.5	*	A	236	920	A	*
210	907	A	*	237	920.5	*	A
211	907.5	*	A	238	921	A	*
212	908	A	*	239	921.5	*	A
213	908.5	*	A	240	922	A	*
214	909	A	*	241	922.5	*	A
215	909.5	*	A	242	923	A	*
216	910	A	*	243	923.5	*	A
217	910.5	*	A	244	924	A	*
218	911	A	*	245	924.5	*	A
219	911.5	*	A	246	925	A	*
220	912	A	*	247	925.5	*	A
221	912.5	*	A	248	926	A	*
222	913	A	*	249	926.5	*	A
223	913.5	*	A	250	927	A	*
224	914	A	*	251	927.5	*	A
225	914.5	*	A	252	928	-	-
226	915	A	*				

Table 12: Channel assignment

## 11. Battery powered operation

For battery-powered operation, the module provides two sleep modes. Each mode can be entered by a specific command and left by applying a falling edge at the *WAKE-UP* pin.

This type of operation is accessible in command mode only.

	Shutdown	Standby
Enter mode	By command CMD_SHUTDOWN_REQ	By command CMD_STANDBY_REQ
Typical current consumption [ $\mu$ A]	0.2	1.6
Wake-up trigger	Falling edge at the <i>WAKE-UP</i> pin	
CPU wake-up time [ms]	See chapter 9	
Wake-up behavior	The module restarts such that all volatile settings are lost.	RAM is retained and module just continues its operation.
Wake-up message	CMD_RESET_IND	CMD_STANDBY_IND

## **12. Custom firmware**

### **12.1. Custom configuration of standard firmware**

The configuration of the standard firmware includes adoption of the non-volatile user settings (see chapter 8) to customer requirements and creating a customized product based on the standard product.

This variant will result in a customer exclusive module with a unique ordering number. It will also freeze the firmware version to a specific and customer tested version and thus results in a customer exclusive module with a unique ordering number.

Further scheduled firmware updates of the standard firmware will not be applied to this variant automatically. Applying updates or further functions require a customer request and release procedure.

### **12.2. Customer specific firmware**

A customer specific firmware may include "Custom configuration of standard firmware" plus additional options or functions and tasks that are customer specific and not part of the standard firmware.

Further scheduled firmware updates of the standard firmware will not be applied to this variant automatically. Applying updates or further functions require a customer request and release procedure.

This also results in a customer exclusive module with a unique ordering number.

An example for this level of customization are functions like host-less operation where the module will perform data generation (e.g. by reading a SPI or I<sup>2</sup>C sensor) and cyclic transmission of this data to a data collector, while sleeping or being passive most of the time.

Also replacing UART with SPI as host communication interface is classified such a custom specific option.

Certification critical changes need to be re-evaluated by an external qualified measurement laboratory. These critical changes may occur when e.g. changing radio parameters, the channel access method, the duty-cycle or in case of various other functions and options possibly used or changed by a customer specific firmware.

### **12.3. Customer firmware**

A customer firmware is a firmware written and tested by the customer himself or a 3rd party as a customer representative specifically for the hardware platform provided by a module.

This customer firmware (e.g. in form of a Intel hex file) will be implemented into the module's production process at our production site.

This also results in a customer exclusive module with a unique ordering number.

The additional information needed for this type of customer firmware, such as hardware specific details and details towards the development of such firmware are not available for the public and can only be made available to qualified customers.



The qualification(s) and certification(s) of the standard firmware cannot be applied to this customer firmware solution without a review and verification.

## 12.4. Contact for firmware requests

Please contact your Business Development Engineer (BDM) or [WCS@we-online.com](mailto:WCS@we-online.com) for quotes regarding these topics.

### 13. Flooding mesh: Using the repeater functionality

The Telesto-III can be run as a repeater to artificially extend the range of sending devices in an existing network.

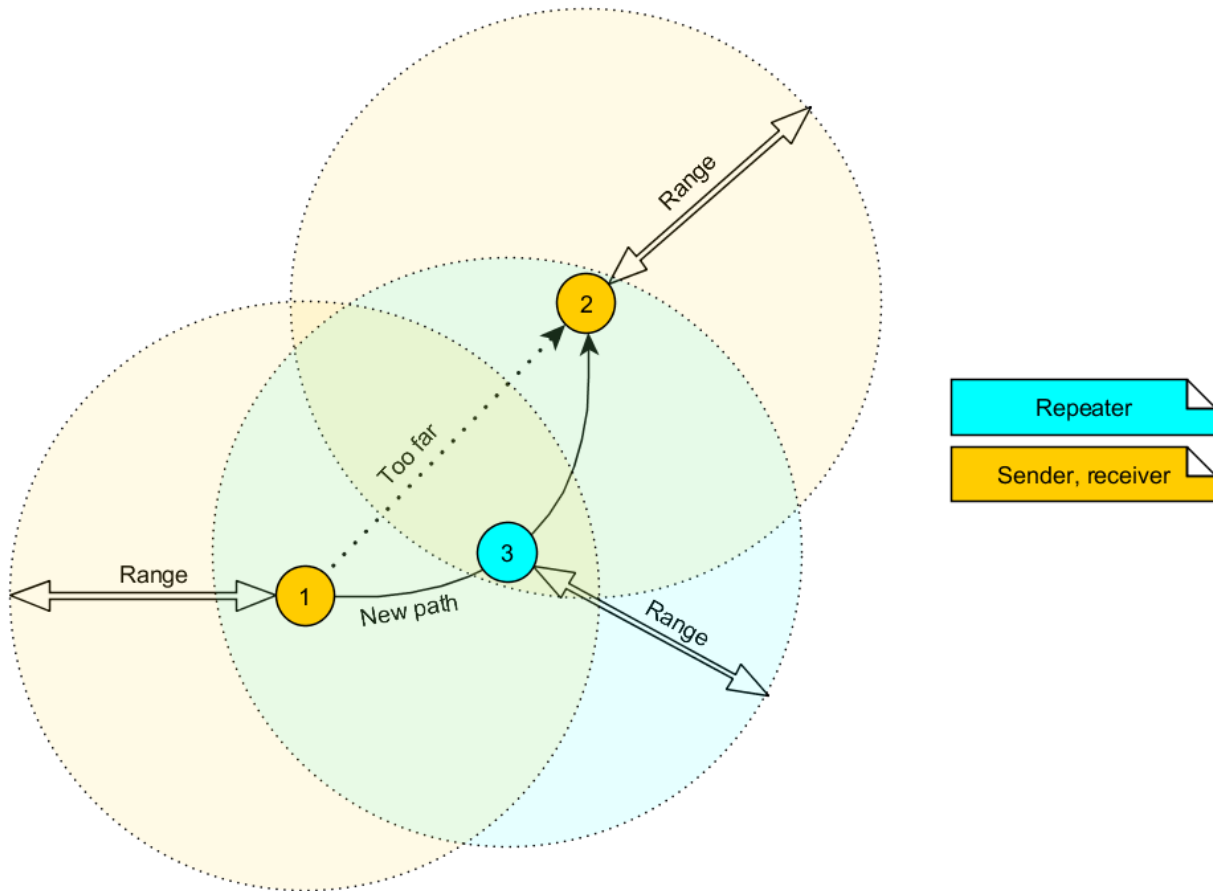

Figure 7: Range extension using several repeaters

If the module is configured as repeater, it can be simply added to existing wireless networks consisting of compatible modules. With this, the newly generated mesh network uses the so-called "flooding technique" to deliver data packets from their source to their destination device. The repeater module itself simply listens to the configured channel and forwards all received packets except the ones addressed to itself. Thereby, a random delay is used to avoid RF packet collision. To reduce traffic on the frequency channel, each repeater device checks before repetition whether it has already sent this packet or not. Thus, every repeater sends each packet only once.

In a network with **NumRP** repeater devices, each data packet is repeated **NumRP** times. Therefore, each packet that is sent from node A to node B forces a traffic of **NumRP+1** data packets in total on the frequency channel.



A module that is configured as repeater simultaneously supports the functions of a standard module. Thus, it can receive data and can initiate the data transmission to other modules.



A host connected to a radio module in repeater mode, is required to adhere to /RTS signal when initiating data transfers.

### 13.1. Setup of the network and repeater device

The repeater mode can be enabled with setting Bit 0 accordingly in the RpFlags.



As ACKs are not supported by the repeater mode, all network members must make sure that the user settings value of MAC\_NumRetrys is set to 0.

If the module is configured as repeater, the following notes have to be considered:

#### 1. Requirements on the network:

- a) The repeater devices must be line-powered (no battery), since the energy consumption is higher, due to the packet repetition.
- b) Depending on the data rate, each repeater should repeat a maximum of 2-5 packets per second, in order to increase the probability that the repeater is not busy with repeating when already a new packet arrives for repetition. Otherwise, packets can get lost. The network shall be setup such that this requirement is fulfilled. More packets per second will result in more packet loss as the collision probability will increase.
- c) If the network consists of several layers of repeaters, each layer delays the packet transmission additionally.
- d) To setup the network, all participants have to use the same RADIO\_DefaultRfProfile, RADIO\_DefaultRfChannel and MAC\_DefaultAddressMode.
- e) The network must be designed by the user in such a way that the duty-cycle requirements of the local regulatory bodies cannot be exceeded.

#### 2. Information for the repeater device:

- a) Acknowledgements (ACK) of successfully received packets are blocked. If an ACK is requested by the sending module, the request is ignored. Furthermore, the repeater does not request any ACK, when repeating a packet.
- b) The "packet sniffer" mode cannot run at the same time as the module is in repeater mode.

- c) Each time a packet has been repeated a `CMD_REPEAT_IND` is output over UART. Depending on the address mode, the address of the involved devices is placed in the `CMD_REPEAT_IND` telegram. With this, the original sender of the RF packet and the device, that is supposed to receive the packet, can be identified.
3. Information for the sending and receiving devices:
- a) The senders should send less frequently to avoid packet collision on the frequency channel and to not exceed the duty cycle requirements.
  - b) The repeater devices do not support the feature of ACKs for the successful reception of the packets. Thus, the sender will never receive ACKs if requested. To ensure that transmitted packets are successfully received by the destination device, the network administrator has to integrate his own acknowledging feature in the customer's application. To be sure that the sender does not request ACKs the user setting `MAC_NumRetrys` must be set to 0.
  - c) Every repeater sends each packet only once. However, receivers can receive each packet several times (sent by different repeaters), if there are packets of different content in the network temporally close to each other. Thus, on the side of the receiving device, a mechanism that detects and filters double packets shall be implemented.

## 13.2. Example network

In the example network shown below, the goal is to send a packet from device 1 to 5. Without the repeater devices, this would be impossible. The steps are as follows:

1. Sender 1 sends a packet.
  - a) Repeater 2 and 3 receive and accept it at the same time.
2. Device 2 and 3 delay the packet.
  - a) Repeater 3 sends the packet.
    - i. Sender 1 and 6 do not accept it, since their addresses are wrong (unequal 5).
    - ii. Repeater 2 does not accept it, since it has been already received before.
  - b) Repeater 2 sends the packet.
    - i. Repeaters 3 does not accept it, since it has been already received before.
    - ii. Sender 1 does not accept it, since its address is wrong (unequal 5).
    - iii. Repeater 4 receives and accepts the packet.
3. Repeater 4 delays and sends the packet.
  - a) Sender 6 and 7 do not accept it, since their addresses are wrong (unequal 5).
  - b) Repeater 2 does not accept it, since it has been already received before.
  - c) Receiver 5 accepts it and its successfully delivered (address equals 5).

Note that the packet forwarded by repeater 2 and 3 would collide in the frequency channel, if they wouldn't be randomly delayed (see `RP_NumSlots`).

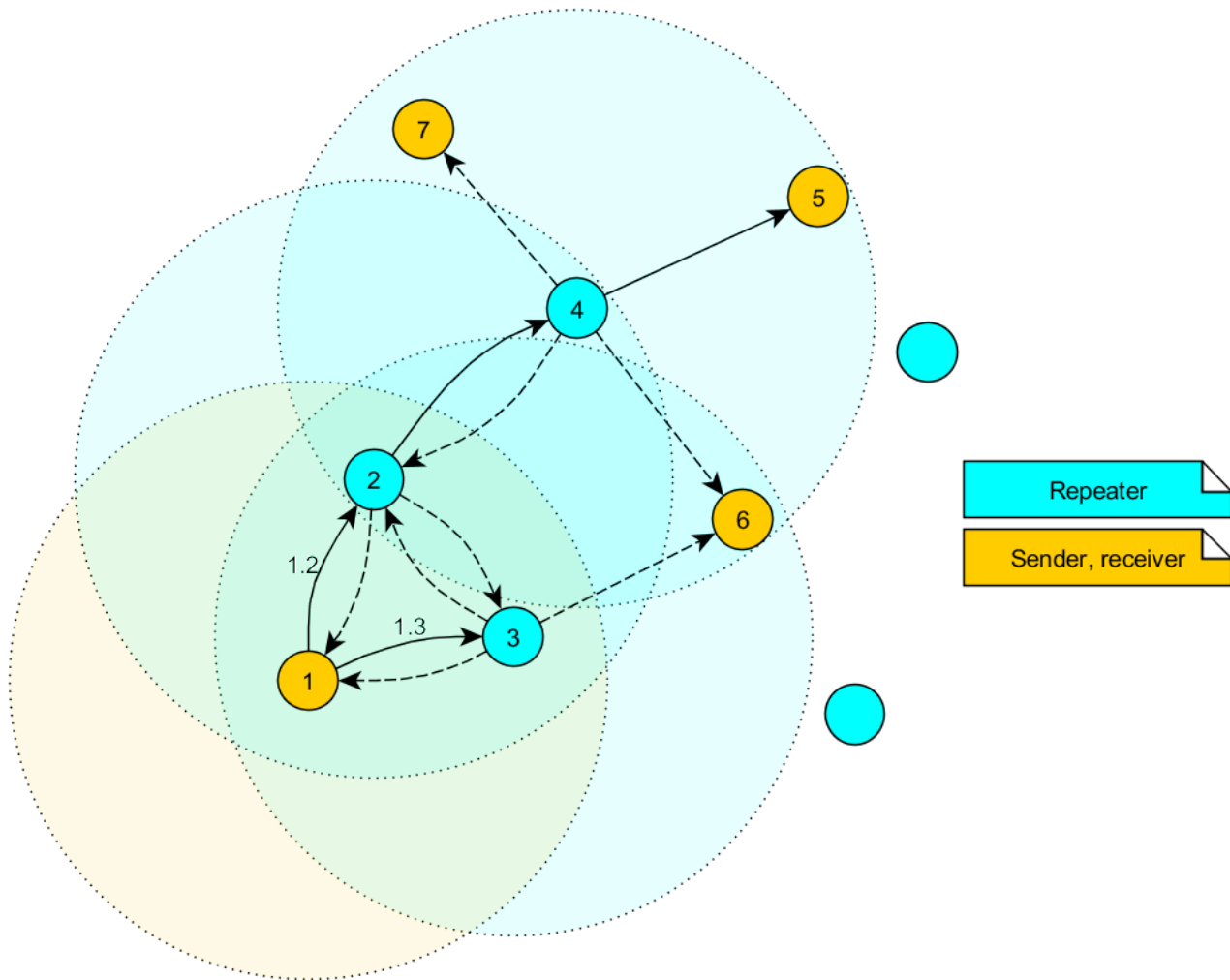

Figure 8: Example network

**13.2.1. Application in parallel networks**

As described above, a repeater device forwards all packets that are received. If a network needs to have a bigger throughput of data, a parallel network can be set up, that relaxes the stress of the primary network. To do so, all sending, receiving and repeater devices of the parallel network are configured to use a new non-overlapping channel, such that the primary network is not affected at all by the traffic of the parallel network. All nodes in the networks shall not be closer to each other than 2 meters. In case it cannot be avoided the TX power parameter of devices close to each other must be reduced.



## 14. Listen Before Talk (LBT)

This section describes the Listen Before Talk (LBT) feature. A radio transmitter performing an LBT, assesses the channel and proceeds with transmission only when the channel is free. This method provides a way for collision avoidance at the cost of latency and throughput.

This function is disabled by default in the Telesto-III module meaning that the module transmits the data without checking if the channel is free.

If LBT is enabled, the module uses a channel access scheme called CSMA-CA (Carrier Sense Multiple Access with Collision Avoidance). The transmitter performs a signal strength measurement on the configured channel. If the measured signal strength is below a certain threshold, the channel is considered to be free and the packet is transmitted. In case the signal strength detected is beyond a certain threshold, the channel is considered to be busy. In this case, the host gets a channel busy status indicated.

To enable and configure this feature, two user settings are used. First of all `LBT_ObservationPeriod`, which is used to enable or disable the feature, where '0' means feature is disabled and any other value enables the feature and specifies for how long to observe the chosen channel.

In addition to this, a threshold `LBT_Threshold` can be configured, which is used for deciding either "channel is free" or "channel is busy".

In the figure 9 below, the procedure to determine if the channel is busy or free depending on the values of the parameters is shown.

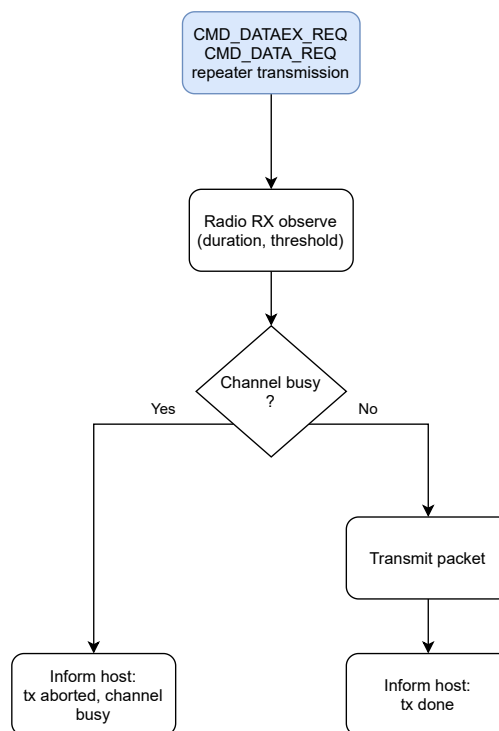

Figure 9: Listen Before Talk

## 15. Firmware updates

All products will experience maintenance, security and/or feature updates from time to time. For the standard products, these are maintained via the PCN process (according to JEDEC standard J-STD-046).

Customers can request the creation of a customized product including a "firmware freeze" to ensure that they will receive their verified product, even if the standard product is updated.

### 15.1. Firmware flashing using the production interface

Most Würth Elektronik eiSos wireless connectivity modules offer a production interface (e.g. JTAG, SWD, Spy-Bi-Wire) for module flash access. Depending on the product, this interface can be used by customers to erase the entire chip and install their own firmware.

Using the production interface is not intended to perform updates of Würth Elektronik eiSos standard product firmware.

Production firmware images and binary files for Würth Elektronik eiSos wireless connectivity modules are not publicly available.



Any certification, declaration, listing and qualification becomes invalid if the production interface is used by a customer. Some products, in their documentation, state exceptions to this invalidation under certain conditions.

Customers shall make the product specific firmware update interface available to their application. These methods will use a wired (UART, SPI, etc.) or wireless (Bluetooth® LE, WiFi, etc.) communication interface of the module to allow updating the product's firmware. Details are described in the next section.

### 15.2. Update via ACC software and UART

Only the *BOOT*, *UTDX*, *URXD* and *GND* signals are needed for this connection. A suitable adapter/converter is required for a PC connection (e.g. the FTDI TTL-323R-3V3 UART to USB converter).

The pin *BOOT* must be on high level (during and shortly after a reset) in order to start the bootloader (details see chapter [Quickstart](#)). The reset signal shall be connectable to GND for performing a reset of the module (e.g. using a push-button which pulls to *GND* when pressed). The */RESET* pin has an internal pull-up of 100 kΩ.



None of the module pins are 5 V TTL compatible. Applying over-voltage to any pin, may damage the hardware permanently. Voltage levels in the range of the electrical specification must be assured, as shown in chapter 2



Users must make sure that their host is not accessing the Telesto-III RX line (i.e. pulling it HIGH or LOW) as that will prevent ACC to access the module.

As long as our standard firmware is running on the module, it can be updated with the PC utility "ACC" via the serial interface. If the module is not directly connected to a PC, then at least the UART should be made accessible, e.g. by means of a suitable connector.

## 16. Firmware history

### Version 2.1.0 "Release"

- Initial release.

### Version 2.4.0 "Release"

- Entering the standby mode, when using the `CMD_STANDBY_REQ` command, is performed with highest priority. Thus, the radio traffic does not influence the standby mode any-more.

### Version 2.5.0 "Release"

- New indication message `CMD_DUTYCYCLE_IND` has been introduced, indicating how much time was used for transmitting. This information can be used to track the duty cycle.

### Version 3.0.0 "Release"

- All new features are optional and need to be explicitly configured or selected by the user.
- Introduction of transparent mode, the `MODE_1` pin and new user settings.
- Optimization of the UART buffers.

### Version 3.3.0 "Engineering"

- Test firmware for selected customers.

### Version 3.3.0 "Release"

- Improve stability of the radio and repeater function under stress.
- The on-time of the pins `TX_IND` and `RX_IND` has been adjusted. They show the accurate time of transmitting/receiving a radio packet now.
- Added Listen Before Talk (LBT) feature. The module will check whether the radio channel is free before starting the data transmission, if this feature is enabled. Default: disabled.
- Added a new busy status for `CMD_DATA_CNF` that is returned when the module is busy (e.g. due to radio channel busy) and it receives either `CMD_DATA_REQ` or `CMD_DATAEX_REQ`.
- Double Packet detection algorithm was adopted. It now only contains 1 frame in case of AddressMode 0. All other AddressMode (1,2 and 3) compare the 9 most recent frame headers for the double packet status.
- Updated random function is applied system wide (e.g. selecting the TX slot for repeated radio frames, radio sequence number)

### 16.1. Known issues

ID	Details	Affected versions
----	---------	-------------------

KI-001	<p><b>Description:</b> TI-RTOS: Additional latencies up to 5 ms due to task priorities may occur.</p> <p><b>Affected functions:</b> System timings.</p> <p><b>Workaround:</b> None</p>	All
KI-002	<p><b>Description:</b> In scenarios with high radio traffic the device may not enter the standby mode properly, if the command <code>CMD_STANDBY_REQ</code> has been placed. In case of misbehaviour the current consumption does not meet the specification.</p> <p><b>Affected functions:</b> Command <code>CMD_STANDBY_REQ</code>.</p> <p><b>Workaround:</b> None</p>	≤ 2.1.0
KI-003	<p><b>Description:</b> In case a <code>CMD_DATAEX_REQ</code> is used with a wrong channel number, the module answers with a <code>CMD_DATAEX_CNF</code> (0x02 0x41 0x01 0x02 0x40) instead of a <code>CMD_DATA_CNF</code> (0x02 0x40 0x01 0x02 0x41) message.</p> <p><b>Affected functions:</b> Command <code>CMD_DATAEX_REQ</code>.</p> <p><b>Workaround:</b> None</p>	≤ 2.4.0
KI-004	<p><b>Description:</b> In case of data transmission with ACK enabled, the commands <code>CMD_DATA_REQ</code> and <code>CMD_DATAEX_REQ</code> may not respond with a <code>CMD_DATA_CNF</code>, if a bit error occurs in the ACK (receiver is located at the range limit or poor radio link).</p> <p><b>Affected functions:</b> Commands <code>CMD_DATA_REQ</code> and <code>CMD_DATAEX_REQ</code>.</p> <p><b>Workaround:</b> In case the module does not respond with a <code>CMD_DATA_CNF</code> within a timeout (depending on the data rate and number of retries configured), reset the radio module and continue with the application.</p>	≤ 2.5.0
KI-005	<p><b>Description:</b> When switching from Command into Transparent Mode using the <code>CMD_SET_MODE_REQ</code> the <i>RTS</i> will stay high till the first byte is received in transparent mode.</p> <p><b>Affected functions:</b> Command <code>CMD_SET_MODE_REQ</code> and flow control function.</p> <p><b>Workaround:</b> Use one of the other methods to enter transparent mode or ignore <i>RTS</i> state for first byte.</p>	3.0.0

<p>KI-006</p>	<p><b>Description:</b> When the repeater is enabled and the module is under stress the module gets stuck in a state where it stops receiving new packets.</p> <p><b>Affected functions:</b> Receiving packets.</p> <p><b>Workaround:</b> Send a packet using the commands CMD_DATA_REQ or CMD_DATAEX_REQ to cause the module to start receiving again after a packet has been transmitted.</p>	<p>≤ 3.0.0</p>
<p>KI-007</p>	<p><b>Description:</b> An engineering firmware image was provided to selected customer under version tag 3.3.0 for update via ACC. However this firmware will not be the final released firmware 3.3.0.</p> <p><b>Affected functions:</b> Random function and Double Packet filtering.</p> <p><b>Workaround:</b> Delete all firmware images for 3.3.0 and re-download them from the ACC server after PCN active date.</p>	<p>3.3.0 (Engineering)</p>

## 17. Design in guide

### 17.1. Advice for schematic and layout

For users with less RF experience it is advisable to closely copy the relating EV-Board with respect to schematic and layout, as it is a proven design. The layout should be conducted with particular care, because even small deficiencies could affect the radio performance and its range or even the conformity.

The following general advice should be taken into consideration:

- A clean, stable power supply is strongly recommended. Interference, especially oscillation can severely restrain range and conformity.
- Variations in voltage level should be avoided.
- LDOs, properly designed in, usually deliver a proper regulated voltage.
- Blocking capacitors and a ferrite bead in the power supply line can be included to filter and smoothen the supply voltage when necessary.



No fixed values can be recommended, as these depend on the circumstances of the application (main power source, interferences etc.).



The use of an external reset IC should be considered if one of the following points is relevant:



- The slew rate of the power supply exceeds the electrical specifications.
- The effect of different current consumptions on the voltage level of batteries or voltage regulators should be considered. The module draws higher currents in certain scenarios like start-up or radio transmit which may lead to a voltage drop on the supply. A restart under such circumstances should be prevented by ensuring that the supply voltage does not drop below the minimum specifications.
- Voltage levels below the minimum recommended voltage level may lead to malfunction. The reset pin of the module shall be held on LOW logic level whenever the VDD is not stable or below the minimum operating Voltage.
- Special care must be taken in case of battery powered systems.

- Elements for ESD protection should be placed on all pins that are accessible from the outside and should be placed close to the accessible area. For example, the RF-pin is accessible when using an external antenna and should be protected.
- ESD protection for the antenna connection must be chosen such as to have a minimum effect on the RF signal. For example, a protection diode with low capacitance such as the 8231606A or a 68 nH air-core coil connecting the RF-line to ground give good results.
- Placeholders for optional antenna matching or additional filtering are recommended.
- The antenna path should be kept as short as possible.



Again, no fixed values can be recommended, as they depend on the influencing circumstances of the application (antenna, interferences etc.).

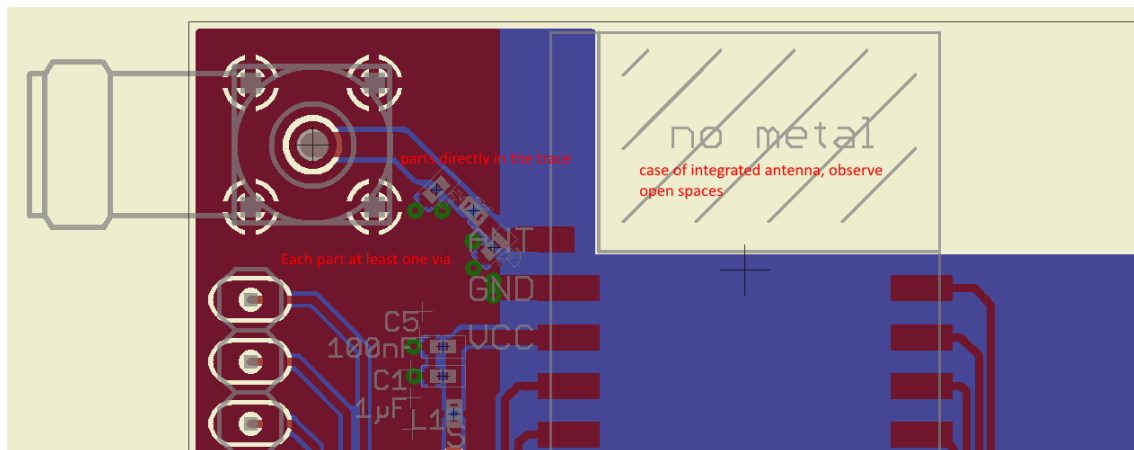

Figure 10: Layout

- To avoid the risk of short circuits and interference there should be no routing underneath the module on the top layer of the baseboard.
- On the second layer, a ground plane is recommended, to provide good grounding and shielding to any following layers and application environment.
- In case of integrated antennas it is required to have areas free from ground. This area should be copied from the EV-Board.
- The area with the integrated antenna must overlap with the carrier board and should not protrude, as it is matched to sitting directly on top of a PCB.
- Modules with integrated antennas should be placed with the antenna at the edge of the main board. It should not be placed in the middle of the main board or far away from the edge. This is to avoid tracks beside the antenna.



- Filter and blocking capacitors should be placed directly in the tracks without stubs, to achieve the best effect.
- Antenna matching elements should be placed close to the antenna / connector, blocking capacitors close to the module.
- Ground connections for the module and the capacitors should be kept as short as possible and with at least one separate through hole connection to the ground layer.
- ESD protection elements should be placed as close as possible to the exposed areas.

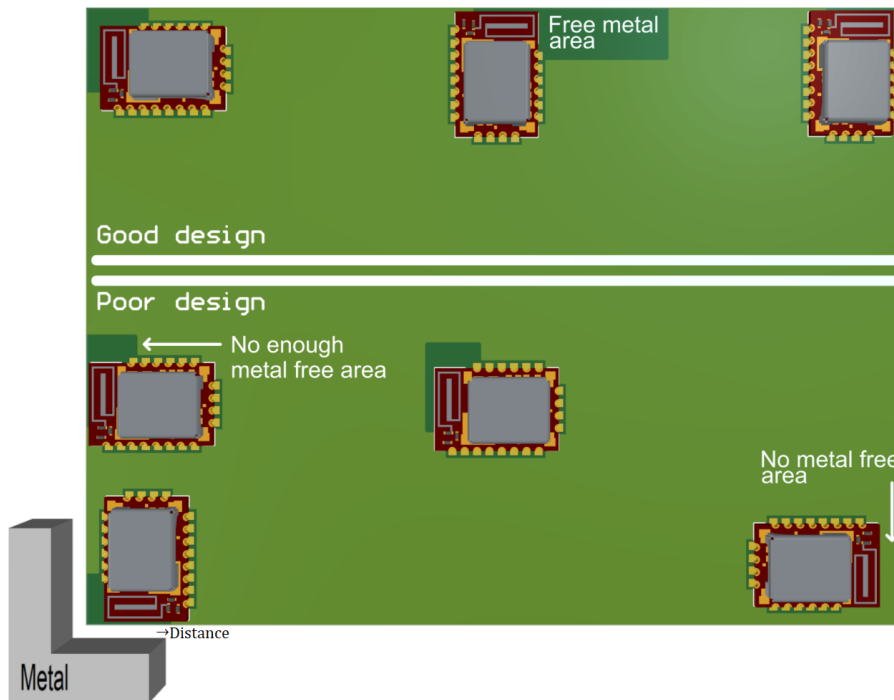

Figure 11: Placement of the module with integrated antenna

## 17.2. Designing the antenna connection

The antenna should be connected with a 50 Ω line. This is needed to obtain impedance matching to the module and avoids reflections. Here we show as an example how to calculate the dimensions of a 50 Ω line in form of a micro strip above ground, as this is easiest to calculate. Other connections like coplanar or strip line are more complicated to calculate but can offer more robustness to EMC. There are free calculation tools available in the internet.

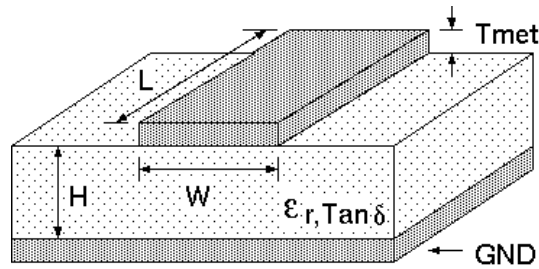

Figure 12: Dimensioning the antenna connection as micro strip

The width W for a micro strip can be calculated using the following equation:

$$W = 1.25 \times \left( \frac{5.98 \times H}{e^{\frac{50 \times \sqrt{\epsilon_r + 1.41}}{87}}} - T_{met} \right) \quad (4)$$

Example:

A FR4 material with  $\epsilon_r = 4.3$ , a height  $H = 1000 \mu\text{m}$  and a copper thickness of  $T_{met} = 18 \mu\text{m}$  will lead to a trace width of  $W \sim 1.9 \text{ mm}$ . To ease the calculation of the micro strip line (or e.g. a coplanar) many calculators can be found in the internet.

- As rule of thumb a distance of about  $3 \times W$  should be observed between the micro strip and other traces / ground.
- The micro strip refers to ground, therefore there has to be the ground plane underneath the trace.
- Keep the feeding line as short as possible.

### 17.3. Antenna solutions

There exist several kinds of antennas, which are optimized for different needs. Chip antennas are optimized for minimal size requirements but at the expense of range, PCB antennas are optimized for minimal costs, and are generally a compromise between size and range. Both usually fit inside a housing.

Range optimization in general is at the expense of space. Antennas that are bigger in size, so that they would probably not fit in a small housing, are usually equipped with a RF connector. A benefit of this connector may be to use it to lead the RF signal through a metal plate (e.g. metal housing, cabinet).

As a rule of thumb a minimum distance of  $\lambda / 10$  (which is 3.5 cm @ 868 MHz and 1.2 cm @ 2.44 GHz) from the antenna to any other metal should be kept. Metal placed further away will not directly influence the behavior of the antenna, but will anyway produce shadowing.



Keep the antenna as far as possible from large metal objects to avoid electro-magnetic field blocking.

In the following chapters, some special types of antenna are described.

### **17.3.1. Wire antenna**

An effective antenna is a  $\lambda / 4$  radiator with a suiting ground plane. The simplest realization is a piece of wire. It's length is depending on the used radio frequency, so for example 8.6 cm 868.0 MHz and 3.1 cm for 2.440 GHz as frequency. This radiator needs a ground plane at its feeding point. Ideally, it is placed vertically in the middle of the ground plane. As this is often not possible because of space requirements, a suitable compromise is to bend the wire away from the PCB respective to the ground plane. The  $\lambda / 4$  radiator has approximately 40  $\Omega$  input impedance. Therefore, matching is not required.

### **17.3.2. Chip antenna**

There are many chip antennas from various manufacturers. The benefit of a chip antenna is obviously the minimal space required and reasonable costs. However, this is often at the expense of range. For the chip antennas, reference designs should be followed as closely as possible, because only in this constellation can the stated performance be achieved.

### **17.3.3. PCB antenna**

PCB antenna designs can be very different. The special attention can be on the miniaturization or on the performance. The benefits of the PCB antenna are their small / not existing (if PCB space is available) costs, however the EV of a PCB antenna holds more risk of failure than the use of a finished antenna. Most PCB antenna designs are a compromise of range and space between chip antennas and connector antennas.

**17.3.4. Antennas provided by Würth Elektronik eiSos**

**17.3.4.1. 2600130086 - Hermippe-III dipole antenna**

Well suited for applications where the RF is lead through a metal wall that could serve as ground plane to the antenna.



Figure 13: Hermippe-III dipole antenna

Specification	Value
Frequency range [MHz]	855 – 915
VSWR (free space,without ground plane)	$\leq 2.0$
Polarisation	Linear
Impedance [ $\Omega$ ]	$50 \pm 5$
Connector	SMA (Male)
Dimensions (L x d) [mm]	$50 \pm 3 \times 7.92 \pm 0.2$
Weight [g]	4.5
Operating temp. [ $^{\circ}\text{C}$ ]	-40 – +85

### 17.3.4.2. 2600130083 - Hydra-I dipole antenna



Figure 14: Hydra-I dipole antenna

Ideally suited for applications where no ground plane is available.

Specification	Value
Center frequency [MHz]	915
Frequency range [MHz]	868 – 928
VSWR	$\leq 2.5$
Wavelength	$\lambda / 4$
Impedance [ $\Omega$ ]	50
Connector	SMA (Male)
Dimensions (L x d) [mm]	179 x 10
Peak gain [dBi]	0.9
Operating temp. [ $^{\circ}\text{C}$ ]	-40 – +80

## **18. Reference design**

Telesto-III was tested and certified on the corresponding Telesto-III EV-Board. For the compliance with the FCC §15.247, the EV-Board serves as reference design.

This is no discrepancy due to the fact that the EV-Board itself does not fall within the scope of FCC §15.247 according to 47 CFR §2.803 (c) exemptions (iv) EV-Kit, as the module is tested on the EV-Board, which is also the recommended use.

Further information concerning the use of the EV-Board can be found in the manual of the Telesto-III EV-Board.

### **18.1. Schematic**

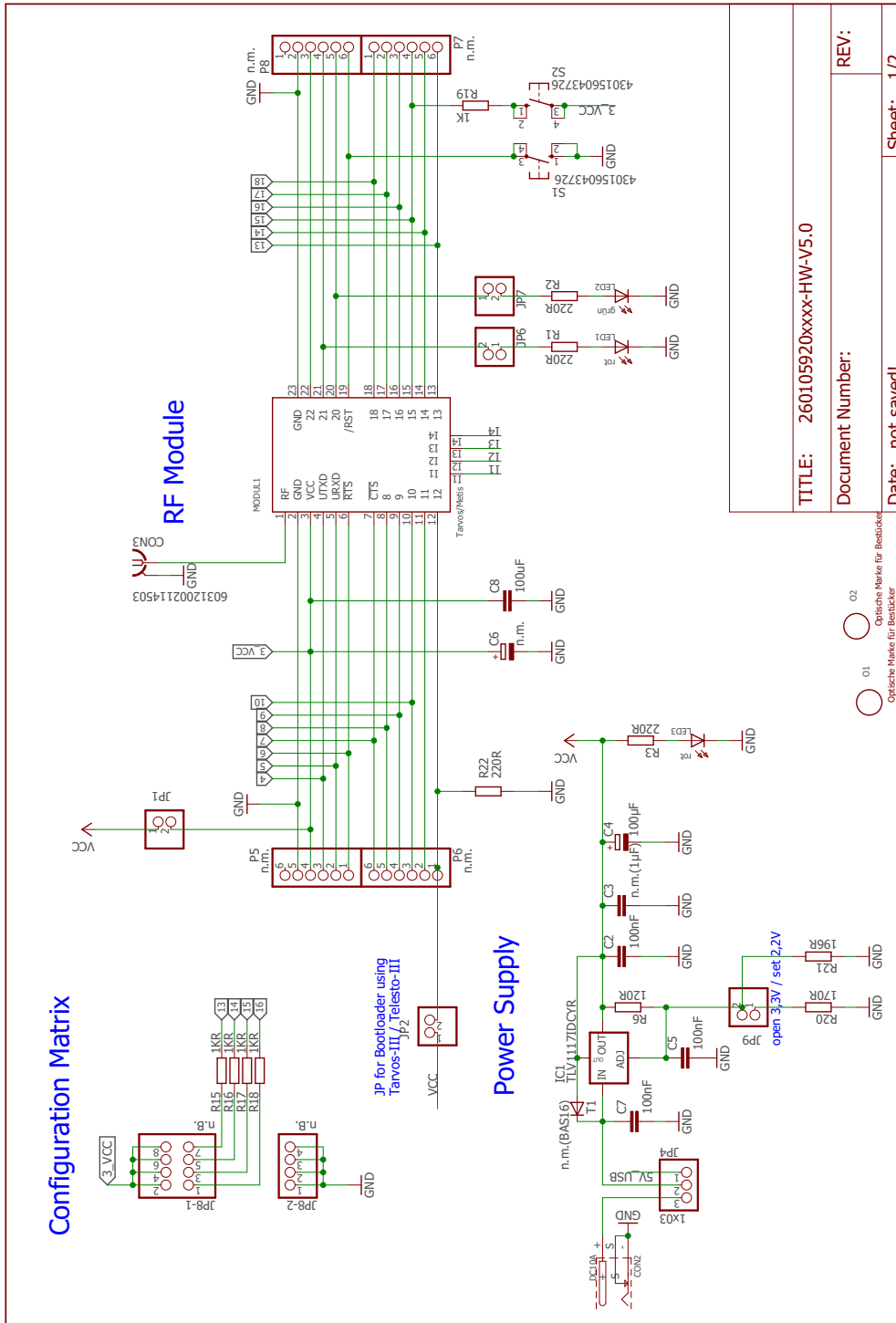

TITLE: 260105920xxxxx-HW-V5.0

Document Number:

REV:

Date: not saved!

Sheet: 1/2

01 Optische Marke für Bestückung  
02 Optische Marke für Bestückung

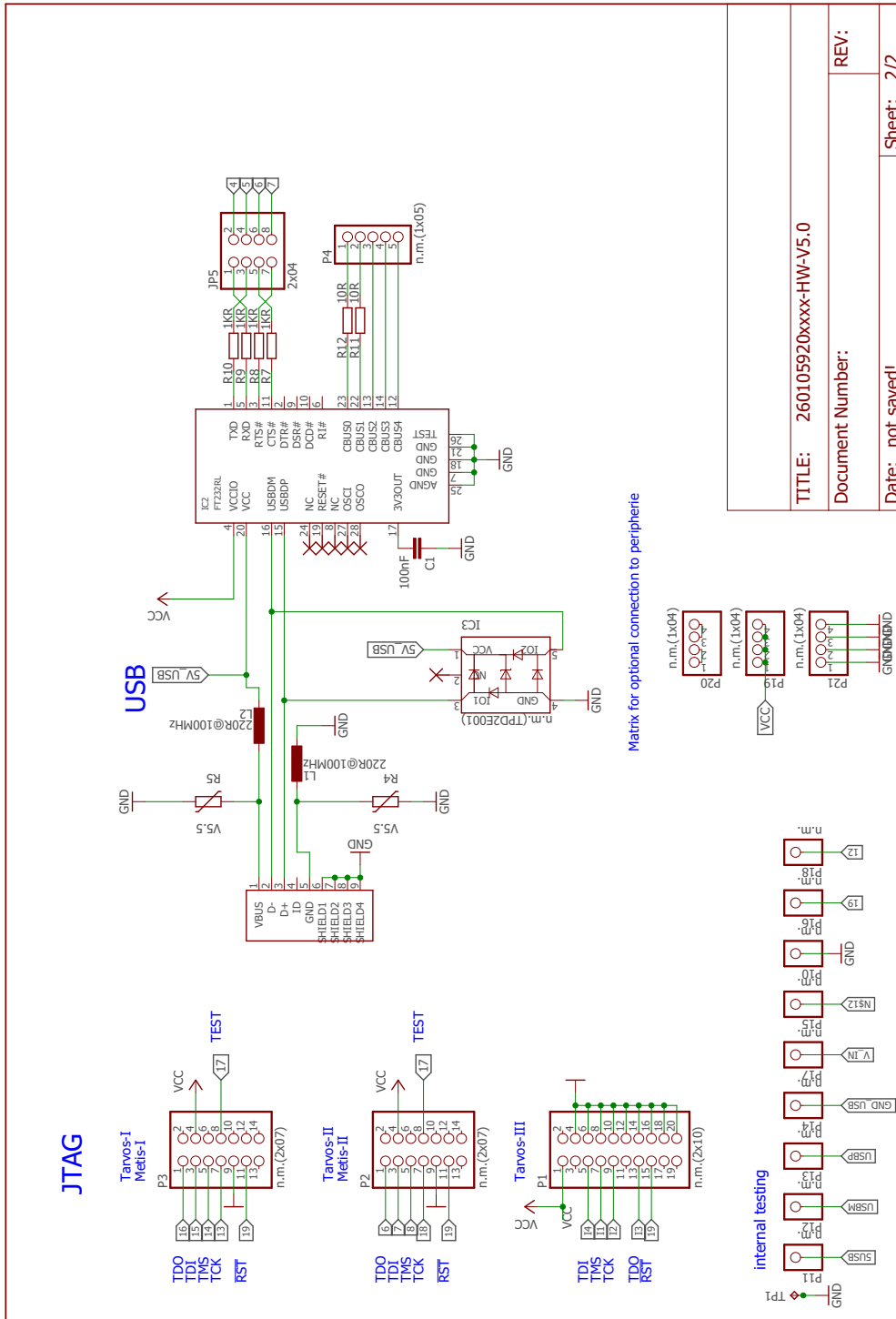

TITLE: 260105920xxxx-HW-V5.0	REV:
Document Number:	REV:
Date: not saved!	Sheet: 2/2



### 18.2. Layout

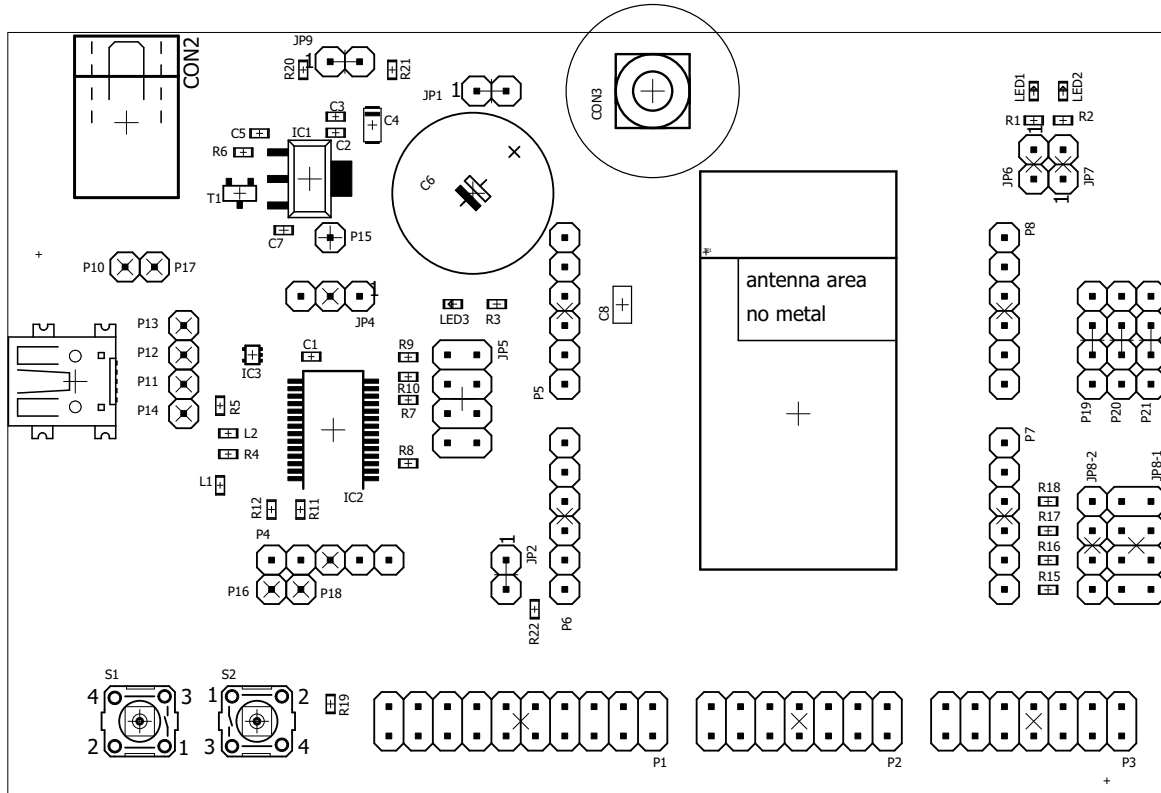

Figure 15: Assembly diagram

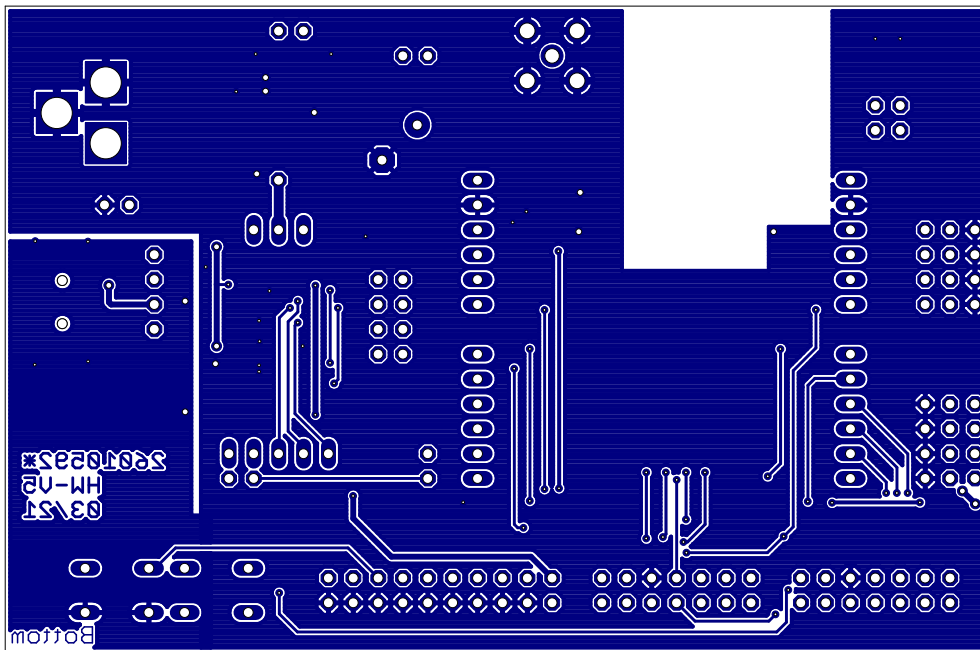
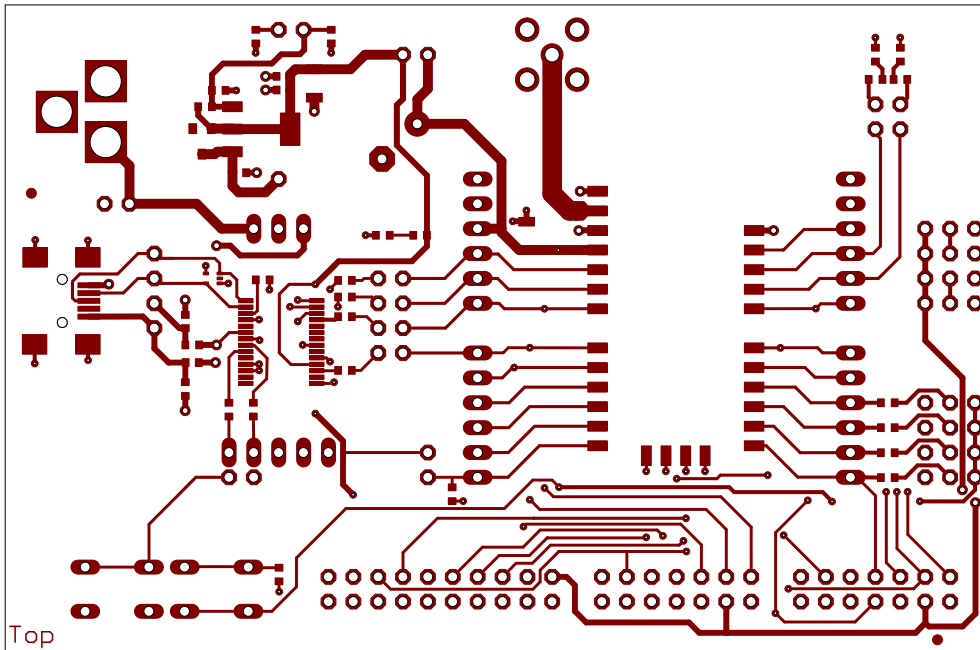

Figure 16: Top and Bottom Layer

### 18.3. Internal antenna radiation characteristics

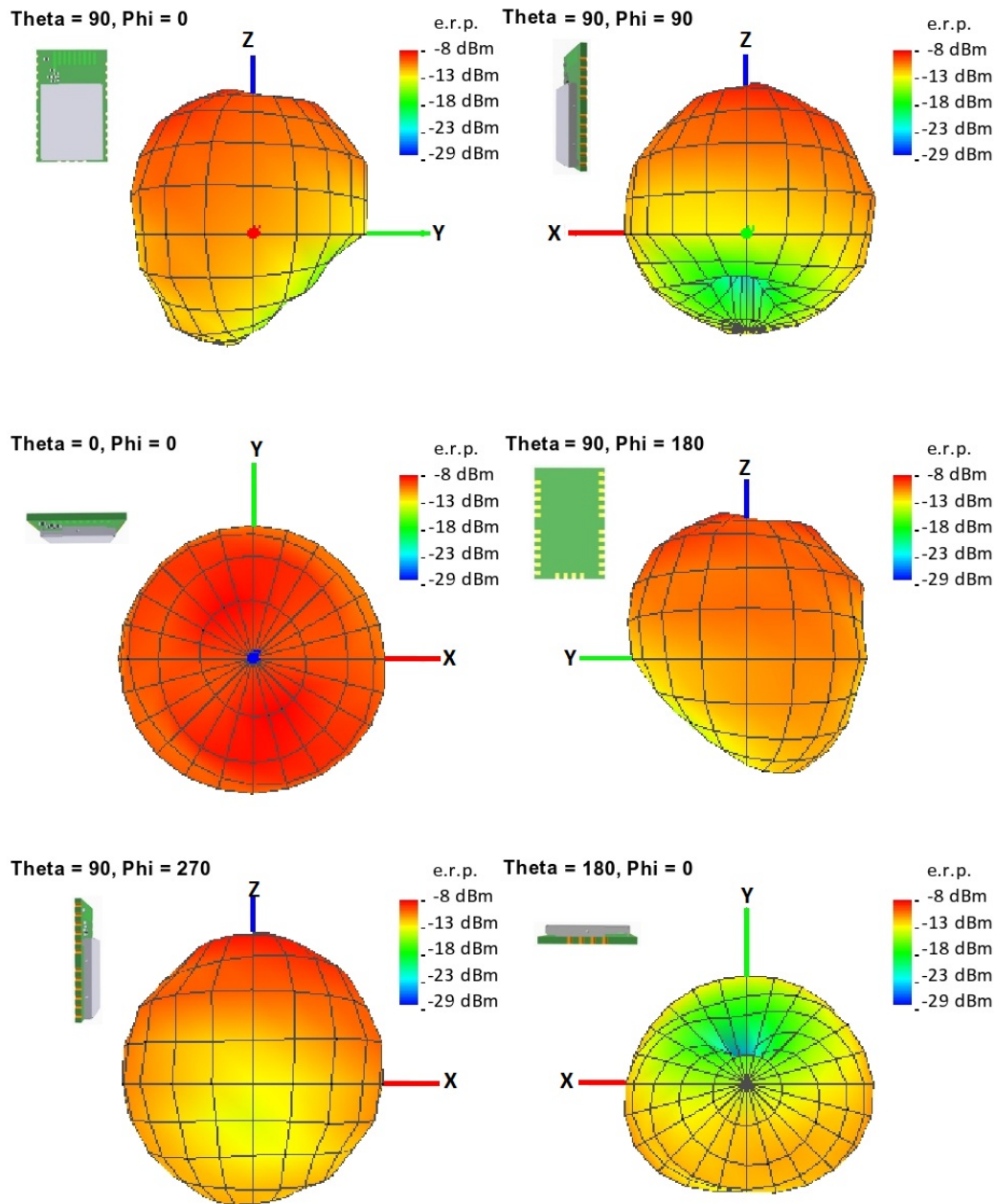

Figure 17: Antenna characteristic from integrated antenna measured on official EV-Board<sup>1</sup>

<sup>1</sup>Radiation characteristic shown is valid for the module on the EV-Board. It is important to be aware that size of groundplane and placement of module has influence on the radiation pattern.

## 19. Manufacturing information

### 19.1. Moisture sensitivity level

This wireless connectivity product is categorized as JEDEC Moisture Sensitivity Level 3 (MSL3), which requires special handling.

More information regarding the MSL requirements can be found in the IPC/JEDEC J-STD-020 standard on [www.jedec.org](http://www.jedec.org).

More information about the handling, picking, shipping and the usage of moisture/reflow and/or process sensitive products can be found in the IPC/JEDEC J-STD-033 standard on [www.jedec.org](http://www.jedec.org).

### 19.2. Soldering

#### 19.2.1. Reflow soldering

Attention must be paid on the thickness of the solder resist between the host PCB top side and the modules bottom side. Only lead-free assembly is recommended according to JEDEC J-STD020.

Profile feature		Value
Preheat temperature Min	$T_{S \text{ Min}}$	150 °C
Preheat temperature Max	$T_{S \text{ Max}}$	200 °C
Preheat time from $T_{S \text{ Min}}$ to $T_{S \text{ Max}}$	$t_S$	60 - 120 seconds
Ramp-up rate ( $T_L$ to $T_P$ )		3 °C / second max.
Liquidous temperature	$T_L$	217 °C
Time $t_L$ maintained above $T_L$	$t_L$	60 - 150 seconds
Peak package body temperature	$T_P$	245 °C
Time within 5 °C of actual peak temperature	$t_P$	20 - 30 seconds
Ramp-down Rate ( $T_P$ to $T_L$ )		6 °C / second max.
Time 20 °C to $T_P$		8 minutes max.

Table 14: Classification reflow soldering profile, Note: refer to IPC/JEDEC J-STD-020E

It is recommended to solder this module on the last reflow cycle of the PCB. For solder paste use a LFM-48W or Indium based SAC 305 alloy (Sn 96.5 / Ag 3.0 / Cu 0.5 / Indium 8.9HF / Type 3 / 89%) type 3 or higher.

The reflow profile must be adjusted based on the thermal mass of the entire populated PCB, heat transfer efficiency of the reflow oven and the specific type of solder paste used. Based on the specific process and PCB layout the optimal soldering profile must be adjusted and verified. Other soldering methods (e.g. vapor phase) have not been verified and have to be validated

by the customer at their own risk. Rework is not recommended.

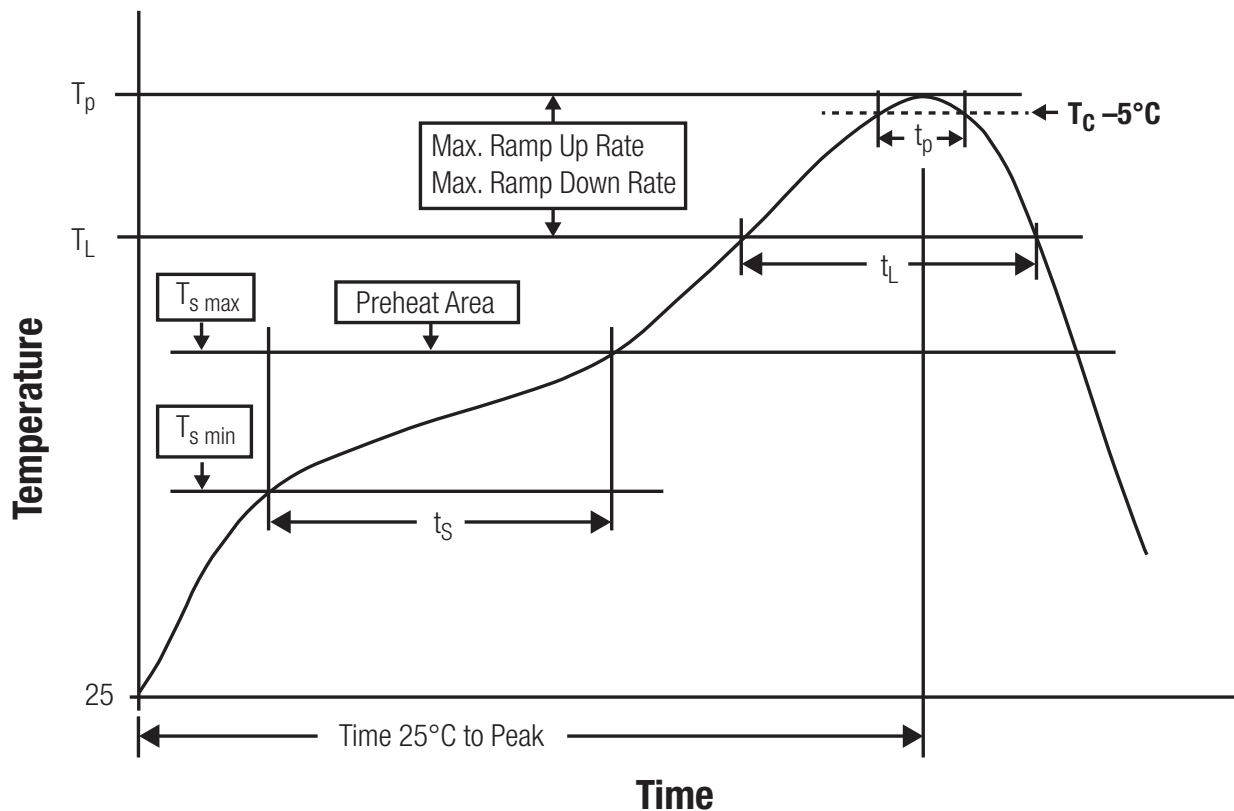

Figure 18: Reflow soldering profile

After reflow soldering, visually inspect the board to confirm proper alignment

### 19.2.2. Cleaning

Do not clean the product. Any residue cannot be easily removed by washing. Use a "no clean" soldering paste and do not clean the board after soldering.

- Do not clean the product with water. Capillary effects can draw water into the gap between the host PCB and the module, absorbing water underneath it. If water is trapped inside, it may short-circuit adjoining pads. The water may also destroy the label and ink-jet printed text on it.
- Cleaning processes using alcohol or other organic solvents may draw solder flux residues into the housing, which won't be detected in a post-wash inspection. The solvent may also destroy the label and ink-jet printed text on it.
- Do not use ultrasonic cleaning as it will permanently damage the part, particularly the crystal oscillators.

### 19.2.3. Potting and coating

- If the product is potted in the customer application, the potting material might shrink or expand during and after hardening. Shrinking could lead to an incomplete seal, allowing contaminants into the component. Expansion could damage components. We recommend a manual inspection after potting to avoid these effects.
- Conformal coating or potting results in loss of warranty.
- The RF shield will not protect the part from low-viscosity coatings and potting. An undefined amount of coating and potting will enter inside the shielding.
- Conformal coating and potting will influence the parts of the radio front end and consequently influence the radio performance.
- Potting will influence the temperature behaviour of the device. This might be critical for components with high power.

### 19.2.4. Other notations

- Do not attempt to improve the grounding by forming metal strips directly to the EMI covers or soldering on ground cables, as it may damage the part and will void the warranty.
- Always solder every pad to the host PCB even if some are unused, to improve the mechanical strength of the module.
- The part is sensitive to ultrasonic waves, as such do not use ultrasonic cleaning, welding or other processing. Any ultrasonic processing will void the warranty.

## 19.3. ESD handling

This product is highly sensitive to electrostatic discharge (ESD). As such, always use proper ESD precautions when handling. Make sure to handle the part properly throughout all stages of production, including on the host PCB where the module is installed. For ESD ratings, refer to the module series' maximum ESD section. For more information, refer to the relevant chapter 2. Failing to follow the aforementioned recommendations can result in severe damage to the part.

- the first contact point when handling the PCB is always between the local GND and the host PCB GND, unless there is a galvanic coupling between the local GND (for example work table) and the host PCB GND.
- Before assembling an antenna patch, connect the grounds.
- While handling the RF pin, avoid contact with any charged capacitors and be careful when contacting any materials that can develop charges (for example coaxial cable with around 50-80 pF/m, patch antenna with around 10 pF, soldering iron etc.)
- Do not touch any exposed area of the antenna to avoid electrostatic discharge. Do not let the antenna area be touched in a non ESD-safe manner.
- When soldering, use an ESD-safe soldering iron.

## 19.4. Safety recommendations

It is your duty to ensure that the product is allowed to be used in the destination country and within the required environment. Usage of the product can be dangerous and must be tested and verified by the end user. Be especially careful of:

- Use in areas with risk of explosion (for example oil refineries, gas stations).
- Use in areas such as airports, aircraft, hospitals, etc., where the product may interfere with other electronic components.

It is the customer's responsibility to ensure compliance with all applicable legal, regulatory and safety-related requirements as well as applicable environmental regulations. Disassembling the product is not allowed. Evidence of tampering will void the warranty.

- Compliance with the instructions in the product manual is recommended for correct product set-up.
- The product must be provided with a consolidated voltage source. The wiring must meet all applicable fire and security prevention standards.
- Handle with care. Avoid touching the pins as there could be ESD damage.

Be careful when working with any external components. When in doubt consult the technical documentation and relevant standards. Always use an antenna with the proper characteristics.



Würth Elektronik eiSos radio modules with high output power of up to 500 mW generate a large amount of heat while transmitting. The manufacturer of the end device must take care of potentially necessary actions for his application.

## 20. Product testing

### 20.1. Würth Elektronik eiSos in-house production tests

To achieve a high quality standard, Würth Elektronik eiSos follows a philosophy of supplying fully tested radio modules. At the end of the production process, every unit undergoes an optical inspection. Here the quality of soldering, edge castellation and edge milling is monitored.

If this has been passed, the radio modules are handed over to the automatic test equipment for the electrical characterization. This includes:

- Voltage and current tests to ensure proper electrical performance
- RF characteristics (frequency, spectrum, TX power) measurement and calibration
- Radio communication tests
- Firmware and serial number programming
- Host interface communication tests

The automated testing process is logged for internal quality control. The gained measurement data of each unit is analysed to detect defective parts and investigate the corresponding root cause. Defective radio modules are discarded, in order to guarantee a 100% failure-free delivery to customers.

### 20.2. EMS production tests

The rigorous in-series production testing ensures that EMS don't need to duplicate firmware tests or measurements. This streamlines the process and eliminates the need for additional testing over analogue and digital interfaces during device production. When it comes to device testing, the ideal focus should be on module assembly quality:

- All module pins are soldered properly on the base PCB
- There are no short circuits
- The mounting process did not damage the module
- The communication between host and radio module is working
- The antenna is connected properly

Simple "Go/No go" tests, like checking the RSSI value, give already a hint if the power supply and antenna have been connected properly.

In addition to such standard testing procedures, radio module integrators have the flexibility to perform additional dedicated tests to thoroughly evaluate the device. Specific tests they can consider are:

- Measure module current consumption in a specified operating state. Deviations from expected results (compared to a "Golden Device") can signal potential issues.



- Perform functional tests, including communication checks with the host controller and verification of interfaces.
- Assess fundamental RF characteristics (modulation accuracy, power levels, spectrum). Verify that the device meets expected performance standards.

## 21. Physical specifications

### 21.1. Dimensions

Dimensions
17 x 27 x 4 mm

Table 15: Dimensions

### 21.2. Weight

Weight
3 g

Table 16: Weight

### 21.3. Module drawing

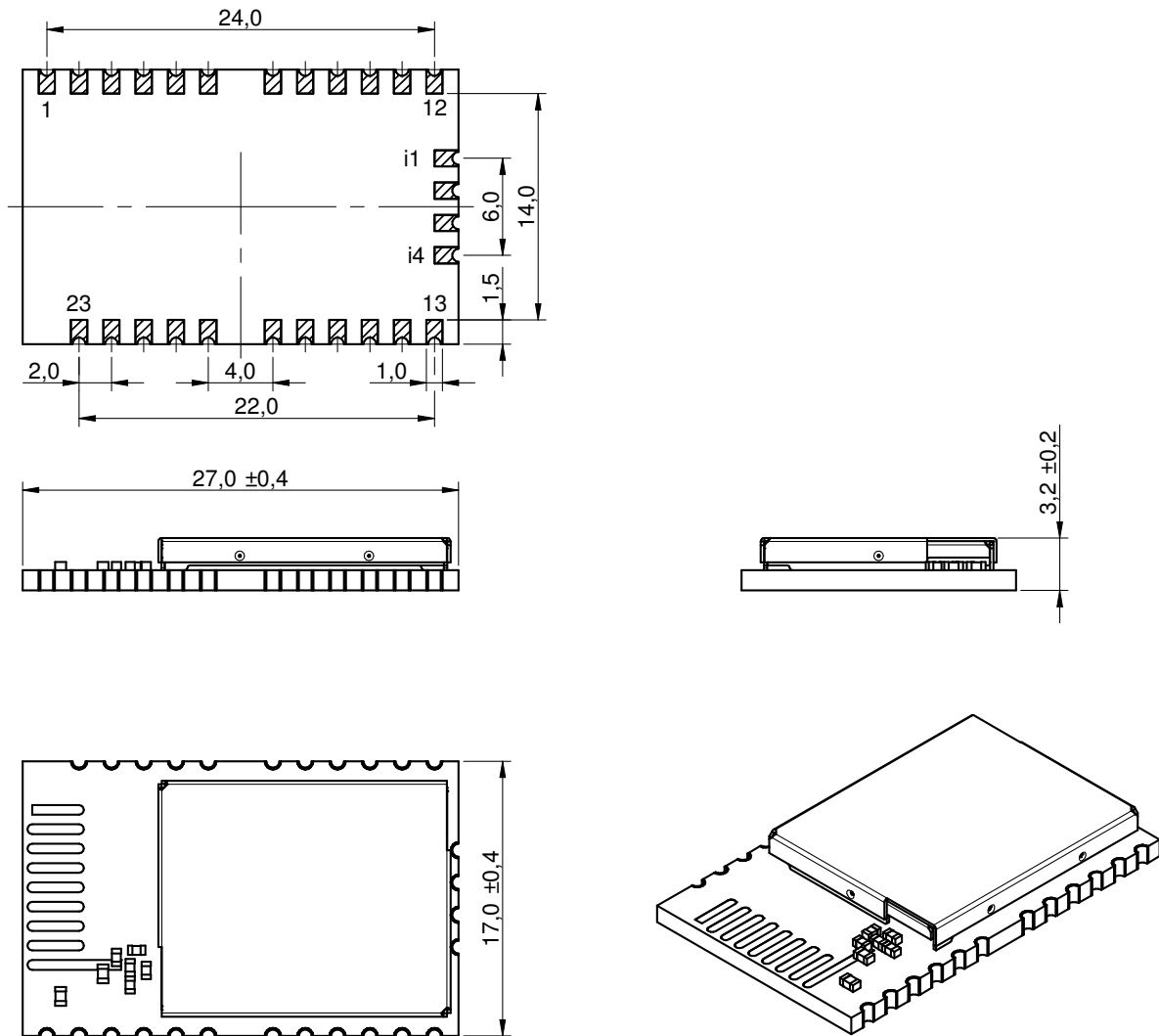

Figure 19: Module dimensions [mm]

## 21.4. Footprint

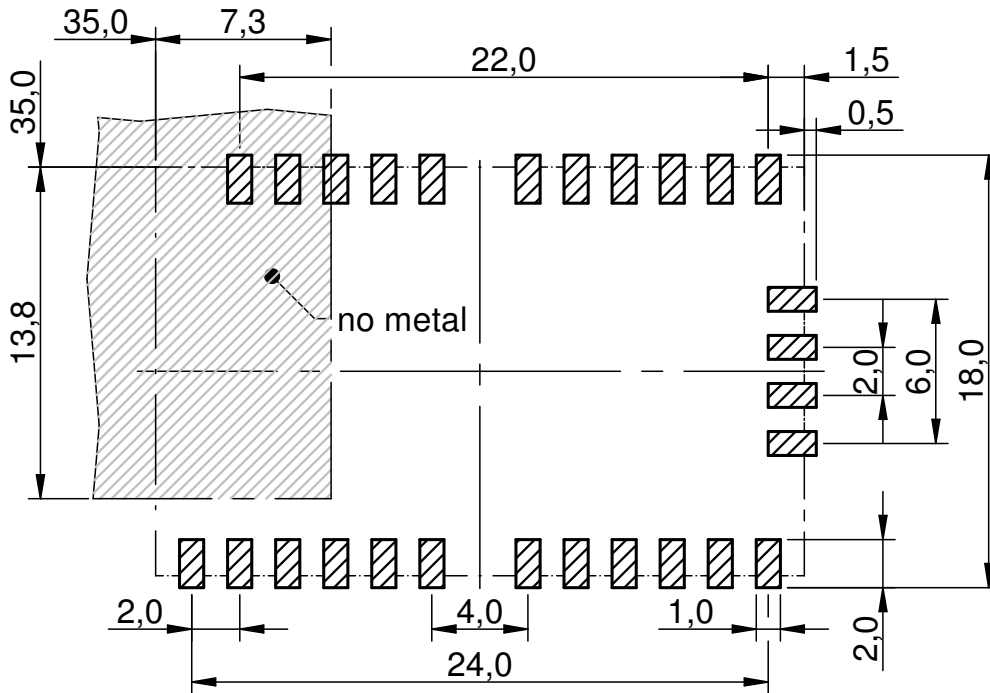

Figure 20: Footprint and dimensions [mm]

The following points have to be considered:

- To avoid the risk of short circuits, a minimum clearance of at least 14 mm between the opposing pad rows has to be maintained. No routing on the top layer of a carrier PCB (i.e. "under" the module) shall be performed.
- For the module variant with integrated antenna, the marked corner area of 7.3 x 13.8 mm has to be kept free from metal, on any layer.
- The four bottom side pads are optional for the firmware update using JTAG. They can be left open when JTAG update is not needed in the customer's application.

## 21.5. Antenna free area

To avoid influence and mismatching of the antenna the recommended free area around the antenna should be maintained. As rule of thumb a minimum distance of metal parts to the antenna of  $\lambda/10$  should be kept (see figure 20). Even though metal parts would influence the characteristic of the antenna, but the direct influence and matching keep an acceptable level.

## 22. Marking

### 22.1. Lot number

The 15 digit lot number is printed in numerical digits as well as in form of a machine readable bar code. It is divided into 5 blocks as shown in the following picture and can be translated according to the following table.

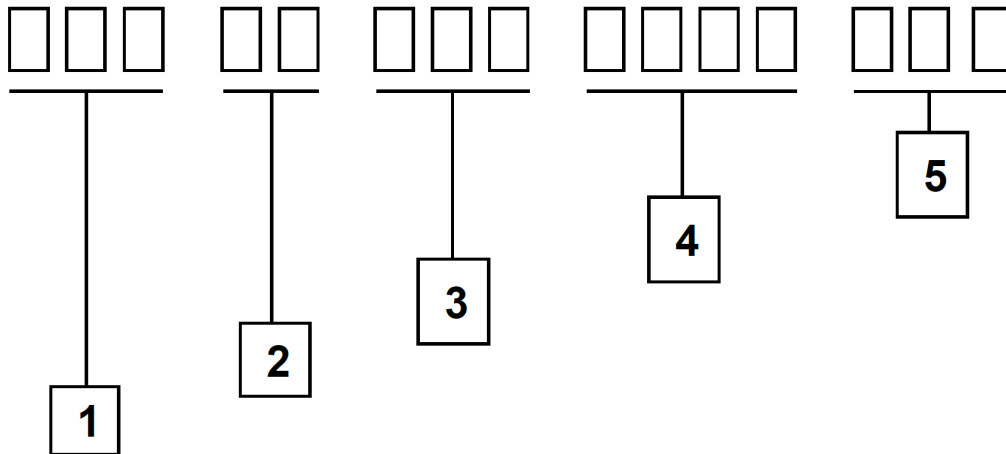

Figure 21: Lot number structure

Block	Information	Example(s)
1	eiSos internal, 3 digits	438
2	eiSos internal, 2 digits	01
3	Radio module hardware version, 3 digits	V2.4 = 024, V12.2 = 122
4	Date code, 4 digits	1703 = week 03 in year 2017, 1816 = week 16 in year 2018
5	Radio module firmware version, 3 digits	V3.2 = 302, V5.13 = 513

Table 17: Lot number details

As the user can perform a firmware update the printed lot number only shows the factory delivery state. The currently installed firmware can be requested from the module using the corresponding product specific command. The firmware version as well as the hardware version are restricted to show only major and minor version not the patch identifier.

## 22.2. General labeling information

Labels of Würth Elektronik eiSos radio modules include several fields. Besides the manufacturer identification, the product's *WE* order code, serial number and certification information are placed on the label. In case of small labels, additional certification marks are placed on the label of the reel.

The information on the label are fixed. Only the serial number changes with each entity of the radio module. For Telesto-III the label is as follows:

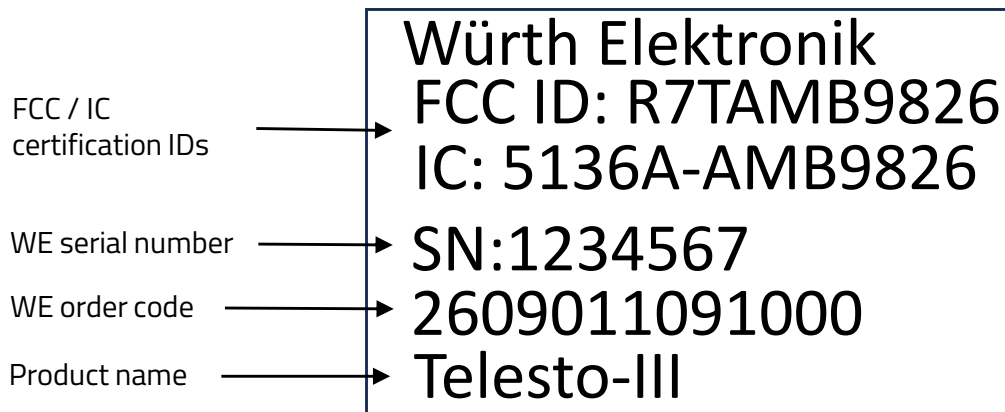

Figure 22: Label of the Telesto-III

## 23. Information for explosion protection

In case the end product should be used in explosion protection areas the following information can be used:

- The maximum output power of the module is 14 dBm.
- The total amount of capacitance of all capacitors is 45.7  $\mu$ F.
- The total amount of inductance of all inductors is 6.9  $\mu$ H.

## **24. Regulatory compliance information**

### **24.1. Important notice FCC**

The use of RF frequencies is limited by national regulations. The Telesto-III has been designed to comply with the FCC Part 15.

The Telesto-III can be operated without notification and free of charge in the area of the United States of America. However, according to the FCC Part 15, restrictions (e.g. in terms of maximum allowed RF power and antenna) may apply.

### **24.2. Conformity assessment of the final product**

The Telesto-III is a subassembly. It is designed to be embedded into other products (products incorporating the Telesto-III are henceforward referred to as "final products").

It is the responsibility of the manufacturer of the final product to ensure that the final product is in compliance with the essential requirements of the underlying national radio regulations.

The conformity assessment of the subassembly Telesto-III carried out by Würth Elektronik eiSos does not replace the required conformity assessment of the final product.

### **24.3. Exemption clause**

Relevant regulation requirements are subject to change. Würth Elektronik eiSos does not guarantee the accuracy of the before mentioned information. Directives, technical standards, procedural descriptions and the like may be interpreted differently by the national authorities. Equally, the national laws and restrictions may vary with the country. In case of doubt or uncertainty, we recommend that you consult with the authorities or official certification organizations of the relevant countries. Würth Elektronik eiSos is exempt from any responsibilities or liabilities related to regulatory compliance.

Notwithstanding the above, Würth Elektronik eiSos makes no representations and warranties of any kind related to their accuracy, correctness, completeness and/or usability for customer applications. No responsibility is assumed for inaccuracies or incompleteness.



## 24.4. FCC Compliance Statement (US)

FCC ID: R7TAMB9826

This device complies with Part 15 of the FCC Rules.

Operation is subject to the following two conditions:

- (1) this device may not cause harmful interference, and
  - (2) this device must accept any interference received, including interference that may cause undesired operation.
- (FCC 15.19)

Modifications (FCC 15.21)

Caution: Changes or modifications for this equipment not expressly approved by Würth Elektronik eiSos may void the FCC authorization to operate this equipment.

### 24.4.1. FCC certificate



**TCB**
**TCB**

**GRANT OF EQUIPMENT AUTHORIZATION**  
 Certification  
 Issued Under the Authority of the  
 Federal Communications Commission  
 By:

Telefication B.V.  
 Edisonstraat 12a  
 Zevenaar, NL-6902 PK  
 Netherlands

Date of Grant: 06/13/2018  
 Application Dated: 05/23/2018

**Wuerth Elektronik eiSos GmbH & Co KG**  
 Max-Eyth-Strasse 1  
 Waldenburger, 54296  
 Germany

Attention: Gudrun Eckhardt, Manager

**NOT TRANSFERABLE**  
 EQUIPMENT AUTHORIZATION is hereby issued to the named GRANTEE, and is VALID ONLY for the equipment identified hereon for use under the Commission's Rules and Regulations listed below.

FCC IDENTIFIER: **R7TAMB9826**  
 Name of Grantee: **Wuerth Elektronik eiSos GmbH & Co KG**  
 Equipment Class: **Part 15 Low Power Communication Device Transmitter**  
 Notes: **AMB9826**  
 Modular Type: **Single Modular**

Grant Notes	FCC Rule Parts	Frequency Range (MHz)	Output Watts	Frequency Emission Tolerance Designator
	<b>15C</b>	<b>902.5 - 927.5</b>	<b>0.022</b>	

Certificate No.:  
182180616/AA/00

George Lo  
Product Assessor



Figure 23: FCC certificate

## 24.5. IC Compliance Statement (Canada)

Certification Number: 5136A-AMB9826

HVIN: AMB9826

This device complies with Industry Canada licence-exempt RSS standard(s). Operation is subject to the following two conditions: (1) this device may not cause harmful interference, and (2) this device must accept any interference received, including interference that may cause undesired operation.

Le présent appareil est conforme aux CNR d'Industrie Canada applicables aux appareils radio exempts de licence. L'exploitation est autorisée aux deux conditions suivantes : (1) l'appareil ne doit pas produire de brouillage, et (2) l'utilisateur de l'appareil doit accepter tout brouillage radioélectrique subi, même si le brouillage est susceptible d'en compromettre le fonctionnement.

### 24.5.1. IC certificate

telefication bv  
The Netherlands  
Chamber of Commerce  
51565536  
www.telefication.com



**telefication**

TECHNICAL ACCEPTANCE CERTIFICATE	CERTIFICAT D'ACCEPTABILITÉ TECHNIQUE
CERTIFICATION No. No. DE CERTIFICATION	5136A-AMB9826
TELEFICATION No. No. DE TELEFICATION	182170161/AA/00
TEST SITE No. No. DE LABORATOIRE	3473A-1
ISSUED TO DÉLIVRÉ A	Wuerth Elektronik eiSos GmbH & Co. KG
TYPE OF EQUIPMENT GENRE DE MATÉRIEL	Spread Spectrum or Digital Device (902-928 MHz)
TRADE NAME AND MODEL MARQUE ET MODELE	Wuerth / 2609011091001 Wuerth / 2609011191001
CERTIFIED TO CERTIFIÉ SELON LE	SPECIFICATION CAHIER DES CHARGES
	RSS-247
	ISSUE EDITION
	2

Certification of equipment means only that the equipment has met the requirements of the above-noted specification. Licence applications, where applicable to use certified equipment, are acted on accordingly by the ISSED issuing office and will depend on the existing radio environment, service and location of operation. This certificate is issued on condition that the holder complies and will continue to comply with the requirements and procedures issued by ISSED. The equipment for which this certificate is issued shall not be manufactured, imported, distributed, leased, offered for sale or sold unless the equipment complies with the applicable technical specifications and procedures issued by ISSED.



La certification du matériel signifie seulement que le matériel a satisfait aux exigences de la norme indiquée ci-dessus. Les demandes de licences nécessaires pour l'utilisation du matériel certifié sont traitées en conséquence par le bureau de délivrance d'ISSE et dépendent des conditions radio ambiantes, du service et de l'emplacement d'exploitation. Le présent certificat est délivré à la condition que le titulaire satisfasse et continue de satisfaire aux exigences et aux procédures d'ISSE. Le matériel à l'égard duquel le présent certificat est délivré ne doit pas être fabriqué, importé, distribué, loué, mis en vente ou vendu à moins d'être conforme aux procédures et aux spécifications techniques applicables publiées par ISSE.

ISSUED BY TELEFICATION BV (NL0001), RECOGNIZED CERTIFICATION BODY BY INNOVATION, SCIENCE AND ECONOMIC DEVELOPMENT CANADA  
DÉLIVRÉ PAR TELEFICATION BV (NL0001), ORGANISME DE CERTIFICATION RECONNU PAR INNOVATION, SCIENCES ET DÉVELOPPEMENT ÉCONOMIQUE CANADA

*I hereby attest that the subject equipment was tested and found in compliance with the above-noted specification.  
J'atteste, par la présente, que le matériel a fait l'objet d'essai et a été jugé conforme à la spécification ci-dessus*

DATE 13 Jun 2018 BY George Lo  
Product Assessor

This certificate has one annex.







laboratory



certification



approvals

Figure 24: IC certificate

## 24.6. FCC and IC requirements to OEM integrators

This module has been granted modular approval. OEM integrators for host products may use the module in their final products without additional FCC/IC (Industry Canada) certification if they meet the following conditions. Otherwise, additional FCC/IC approvals must be obtained. The host product with the module installed must be evaluated for simultaneous transmission requirements.

- The users manual for the host product must clearly indicate the operating requirements and conditions that must be observed to ensure compliance with current FCC/IC RF exposure guidelines.
- To comply with FCC/IC regulations limiting both maximum RF output power and human exposure to RF radiation, the maximum antenna gain including cable loss in a mobile-only exposure condition must not exceed 2dBi.
- A label must be affixed to the outside of the host product with the following statements:  
This device contains FCCID: R7TAMB9826  
This equipment contains equipment certified under ICID: 5136A-AMB9826
- The final host / module combination may also need to be evaluated against the FCC Part 15B criteria for unintentional radiators in order to be properly authorized for operation as a Part 15 digital device.
- If the final host / module combination is intended for use as a portable device (see classifications below) the host manufacturer is responsible for separate approvals for the SAR requirements from FCC Part 2.1093 and RSS-102.

### **OEM requirements:**

The OEM must ensure that the following conditions are met.

- End users of products, which contain the module, must not have the ability to alter the firmware that governs the operation of the module. The agency grant is valid only when the module is incorporated into a final product by OEM integrators.
- The end-user must not be provided with instructions to remove, adjust or install the module.
- The Original Equipment Manufacturer (OEM) must ensure that FCC labeling requirements are met. This includes a clearly visible label on the outside of the final product. Attaching a label to a removable portion of the final product, such as a battery cover, is not permitted.
- The label must include the following text:  
*Contains FCC ID: R7TAMB9826*  
*The enclosed device complies with Part 15 of the FCC Rules. Operation is subject to the following two conditions:*  
*(i.) this device may not cause harmful interference and*  
*(ii.) this device must accept any interference received, including interference that may cause undesired operation.*

When the device is so small or for such use that it is not practicable to place the statement above on it, the information required by this paragraph shall be placed in a prominent location in the instruction manual or pamphlet supplied to the user or, alternatively, shall be placed on the container in which the device is marketed. However, the FCC identifier or the unique identifier, as appropriate, must be displayed on the device.

- The user manual for the end product must also contain the text given above.
  - Changes or modifications not expressly approved could void the user's authority to operate the equipment.
  - The OEM must ensure that timing requirements according to 47 CFR 15.231(a-c) are met.
  - The OEM must sign the OEM Modular Approval Agreement.
  - The module must be used with only the following approved antenna(s).

## **24.7. Pre-certified antennas**

The module variants HVIN AMB9826 and AMB9826-1 collected in the PMN AMB9826 are identical in enclosure, appearance, PCB design and bands/technologies. The only difference is, that in AMB9826 an integrated chip antenna is used and for the AMB9826-1 an external  $\lambda/4$  antenna is used.

## 25. Important notes

The following conditions apply to all goods within the wireless connectivity and sensors product range of Würth Elektronik eiSos GmbH & Co. KG:

### General customer responsibility

Some goods within the product range of Würth Elektronik eiSos GmbH & Co. KG contain statements regarding general suitability for certain application areas. These statements about suitability are based on our knowledge and experience of typical requirements concerning the areas, serve as general guidance and cannot be estimated as binding statements about the suitability for a customer application. The responsibility for the applicability and use in a particular customer design is always solely within the authority of the customer. Due to this fact, it is up to the customer to evaluate, where appropriate to investigate and to decide whether the device with the specific product characteristics described in the product specification is valid and suitable for the respective customer application or not. Accordingly, the customer is cautioned to verify that the documentation is current before placing orders.

### Customer responsibility related to specific, in particular safety-relevant applications

It has to be clearly pointed out that the possibility of a malfunction of electronic components or failure before the end of the usual lifetime cannot be completely eliminated in the current state of the art, even if the products are operated within the range of the specifications. The same statement is valid for all software source code and firmware parts contained in or used with or for products in the wireless connectivity and sensor product range of Würth Elektronik eiSos GmbH & Co. KG. In certain customer applications requiring a high level of safety and especially in customer applications in which the malfunction or failure of an electronic component could endanger human life or health, it must be ensured by most advanced technological aid of suitable design of the customer application that no injury or damage is caused to third parties in the event of malfunction or failure of an electronic component.

### Best care and attention

Any product-specific data sheets, manuals, application notes, PCNs, warnings and cautions must be strictly observed in the most recent versions and matching to the products revisions. These documents can be downloaded from the product specific sections on the wireless connectivity and sensors homepage.

### Customer support for product specifications

Some products within the product range may contain substances, which are subject to restrictions in certain jurisdictions in order to serve specific technical requirements. Necessary information is available on request. In this case, the Business Development Engineer (BDM) or the internal sales person in charge should be contacted who will be happy to support in this matter.

### Product improvements

Due to constant product improvement, product specifications may change from time to time. As a standard reporting procedure of the Product Change Notification (PCN) according to the JEDEC-Standard, we inform about major changes. In case of further queries regarding the PCN, the Business Development Engineer (BDM), the internal sales person or the technical support team in charge should be contacted. The basic responsibility of the customer as per section 25 and 25 remains unaffected.

All software like "wireless connectivity SDK", "Sensor SDK" or other source codes as well as all PC software tools are not subject to the Product Change Notification information process.

### Product life cycle

Due to technical progress and economical evaluation, we also reserve the right to discontinue production and delivery of products. As a standard reporting procedure of the Product Termination Notification (PTN) according to the JEDEC-Standard we will inform at an early stage about inevitable product discontinuance. According to this, we cannot ensure that all products within our product range will always be available. Therefore, it needs to be verified with the Business Development Engineer (BDM) or the internal sales person in charge about the current product availability expectancy before or when the product for application design-in disposal is considered. The approach named above does not apply in the case of individual agreements deviating from the foregoing for customer-specific products.

### Property rights

All the rights for contractual products produced by Würth Elektronik eiSos GmbH & Co. KG on the basis of ideas, development contracts as well as models or templates that are subject to copyright, patent or commercial protection supplied to the customer will remain with Würth Elektronik eiSos GmbH & Co. KG. Würth Elektronik eiSos GmbH & Co. KG does not warrant or represent that any license, either expressed or implied, is granted under any patent right, copyright, mask work right, or other intellectual property right relating to any combination, application, or process in which Würth Elektronik eiSos GmbH & Co. KG components or services are used.

### General terms and conditions

Unless otherwise agreed in individual contracts, all orders are subject to the current version of the "General Terms and Conditions of Würth Elektronik eiSos Group", last version available at [www.we-online.com](http://www.we-online.com).

## 26. Legal notice

### Exclusion of liability

Würth Elektronik eiSos GmbH & Co. KG considers the information in this document to be correct at the time of publication. However, Würth Elektronik eiSos GmbH & Co. KG reserves the right to modify the information such as technical specifications or functions of its products or discontinue the production of these products or the support of one of these products without any written announcement or notification to customers. The customer must make sure that the information used corresponds to the latest published information. Würth Elektronik eiSos GmbH & Co. KG does not assume any liability for the use of its products. Würth Elektronik eiSos GmbH & Co. KG does not grant licenses for its patent rights or for any other of its intellectual property rights or third-party rights.

Notwithstanding anything above, Würth Elektronik eiSos GmbH & Co. KG makes no representations and/or warranties of any kind for the

provided information related to their accuracy, correctness, completeness, usage of the products and/or usability for customer applications. Information published by Würth Elektronik eiSos GmbH & Co. KG regarding third-party products or services does not constitute a license to use such products or services or a warranty or endorsement thereof.

#### Suitability in customer applications

The customer bears the responsibility for compliance of systems or units, in which Würth Elektronik eiSos GmbH & Co. KG products are integrated, with applicable legal regulations. Customer acknowledges and agrees that it is solely responsible for compliance with all legal, regulatory and safety-related requirements concerning its products, and any use of Würth Elektronik eiSos GmbH & Co. KG components in its applications, notwithstanding any applications-related information or support that may be provided by Würth Elektronik eiSos GmbH & Co. KG. Customer represents and agrees that it has all the necessary expertise to create and implement safeguards which anticipate dangerous consequences of failures, monitor failures and their consequences lessen the likelihood of failures that might cause harm and take appropriate remedial actions. The customer will fully indemnify Würth Elektronik eiSos GmbH & Co. KG and its representatives against any damages arising out of the use of any Würth Elektronik eiSos GmbH & Co. KG components in safety-critical applications.

#### Trademarks

AMBER wireless is a registered trademark of Würth Elektronik eiSos GmbH & Co. KG. All other trademarks, registered trademarks, and product names are the exclusive property of the respective owners.

#### Usage restriction

Würth Elektronik eiSos GmbH & Co. KG products have been designed and developed for usage in general electronic equipment only. This product is not authorized for use in equipment where a higher safety standard and reliability standard is especially required or where a failure of the product is reasonably expected to cause severe personal injury or death, unless the parties have executed an agreement specifically governing such use. Moreover, Würth Elektronik eiSos GmbH & Co. KG products are neither designed nor intended for use in areas such as military, aerospace, aviation, nuclear control, submarine, transportation (automotive control, train control, ship control), transportation signal, disaster prevention, medical, public information network etc. Würth Elektronik eiSos GmbH & Co. KG must be informed about the intent of such usage before the design-in stage. In addition, sufficient reliability evaluation checks for safety must be performed on every electronic component, which is used in electrical circuits that require high safety and reliability function or performance. By using Würth Elektronik eiSos GmbH & Co. KG products, the customer agrees to these terms and conditions.

## 27. License terms

These License terms will take effect upon the purchase and usage of the Würth Elektronik eiSos GmbH & Co. KG wireless connectivity products. You hereby agree that these license terms are applicable to the product and the incorporated software, firmware and source codes (collectively, "Software") made available by Würth Elektronik eiSos in any form, including but not limited to binary, executable or source code form. The software included in any Würth Elektronik eiSos wireless connectivity product is purchased to you on the condition that you accept the terms and conditions of these license terms. You agree to comply with all provisions under these license terms.

#### Limited license

Würth Elektronik eiSos hereby grants you a limited, non-exclusive, non-transferable and royalty-free license to use the software and under the conditions that will be set forth in these license terms. You are free to use the provided software only in connection with one of the products from Würth Elektronik eiSos to the extent described in these license terms. You are entitled to change or alter the source code for the sole purpose of creating an application embedding the Würth Elektronik eiSos wireless connectivity product. The transfer of the source code to third parties is allowed to the sole extent that the source code is used by such third parties in connection with our product or another hardware provided by Würth Elektronik eiSos under strict adherence of these license terms. Würth Elektronik eiSos will not assume any liability for the usage of the incorporated software and the source code. You are not entitled to transfer the source code in any form to third parties without prior written consent of Würth Elektronik eiSos.

You are not allowed to reproduce, translate, reverse engineer, decompile, disassemble or create derivative works of the incorporated software and the source code in whole or in part. No more extensive rights to use and exploit the products are granted to you.

#### Usage and obligations

The responsibility for the applicability and use of the Würth Elektronik eiSos wireless connectivity product with the incorporated firmware in a particular customer design is always solely within the authority of the customer. Due to this fact, it is up to you to evaluate and investigate, where appropriate, and to decide whether the device with the specific product characteristics described in the product specification is valid and suitable for your respective application or not.

You are responsible for using the Würth Elektronik eiSos wireless connectivity product with the incorporated firmware in compliance with all applicable product liability and product safety laws. You acknowledge to minimize the risk of loss and harm to individuals and bear the risk for failure leading to personal injury or death due to your usage of the product.

Würth Elektronik eiSos' products with the incorporated firmware are not authorized for use in safety-critical applications, or where a failure of the product is reasonably expected to cause severe personal injury or death. Moreover, Würth Elektronik eiSos' products with the incorporated firmware are neither designed nor intended for use in areas such as military, aerospace, aviation, nuclear control, submarine, transportation (automotive control, train control, ship control), transportation signal, disaster prevention, medical, public information network etc. You shall inform Würth Elektronik eiSos about the intent of such usage before design-in stage. In certain customer applications requiring a very high level of safety and in which the malfunction or failure of an electronic component could endanger human life or health, you must ensure to have all necessary expertise in the safety and regulatory ramifications of your applications. You acknowledge and agree that you are solely responsible for all legal, regulatory and safety-related requirements concerning your products and any use of Würth Elektronik eiSos' products with the incorporated firmware in such safety-critical applications, notwithstanding any applications-related information or support that may be provided by Würth Elektronik eiSos. **YOU SHALL INDEMNIFY WÜRTH ELEKTRONIK EISOS AGAINST ANY DAMAGES ARISING OUT OF THE USE OF WÜRTH ELEKTRONIK EISOS' PRODUCTS WITH THE INCORPORATED FIRMWARE IN SUCH SAFETY-CRITICAL APPLICATIONS.**

#### Ownership

The incorporated firmware created by Würth Elektronik eiSos is and will remain the exclusive property of Würth Elektronik eiSos.

#### Firmware update(s)

You have the opportunity to request the current and actual firmware for a bought wireless connectivity product within the time of warranty. However, Würth Elektronik eiSos has no obligation to update a modules firmware in their production facilities, but can offer this as a service on request. The upload of firmware updates falls within your responsibility, e.g. via ACC or another software for firmware updates. Firmware updates will not be communicated automatically. It is within your responsibility to check the current version of a firmware in the latest version of the product manual on our website. The revision table in the product manual provides all necessary information about firmware updates. There is no right to be provided with binary files, so called "firmware images", those could be flashed through JTAG, SWD, Spi-Bi-Wire, SPI or similar interfaces.

#### Disclaimer of warranty

THE FIRMWARE IS PROVIDED "AS IS". YOU ACKNOWLEDGE THAT WÜRTH ELEKTRONIK EISOS MAKES NO REPRESENTATIONS AND WARRANTIES OF ANY KIND RELATED TO, BUT NOT LIMITED TO THE NON-INFRINGEMENT OF THIRD PARTIES' INTELLECTUAL PROPERTY RIGHTS OR THE MERCHANTABILITY OR FITNESS FOR YOUR INTENDED PURPOSE OR USAGE. WÜRTH ELEKTRONIK EISOS DOES NOT WARRANT OR REPRESENT THAT ANY LICENSE, EITHER EXPRESS OR IMPLIED, IS GRANTED UNDER ANY PATENT RIGHT, COPYRIGHT, MASK WORK RIGHT, OR OTHER INTELLECTUAL PROPERTY RIGHT RELATING TO ANY COMBINATION, MACHINE, OR PROCESS IN WHICH THE WÜRTH ELEKTRONIK EISOS' PRODUCT WITH THE INCORPORATED FIRMWARE IS USED. INFORMATION PUBLISHED BY WÜRTH ELEKTRONIK EISOS REGARDING THIRD-PARTY PRODUCTS OR SERVICES DOES NOT CONSTITUTE A LICENSE FROM WÜRTH ELEKTRONIK EISOS TO USE SUCH PRODUCTS OR SERVICES OR A WARRANTY OR ENDORSEMENT THEREOF.

#### Limitation of liability

Any liability not expressly provided by Würth Elektronik eiSos shall be disclaimed.

You agree to hold us harmless from any third-party claims related to your usage of the Würth Elektronik eiSos' products with the incorporated firmware, software and source code. Würth Elektronik eiSos disclaims any liability for any alteration, development created by you or your customers as well as for any combination with other products.

#### Applicable law and jurisdiction

Applicable law to these license terms shall be the laws of the Federal Republic of Germany. Any dispute, claim or controversy arising out of or relating to these license terms shall be resolved and finally settled by the court competent for the location of Würth Elektronik eiSos registered office.

#### Severability clause

If a provision of these license terms is or becomes invalid, unenforceable or null and void, this shall not affect the remaining provisions of the terms. The parties shall replace any such provisions with new valid provisions that most closely approximate the purpose of the terms.

#### Miscellaneous

Würth Elektronik eiSos reserves the right at any time to change these terms at its own discretion. It is your responsibility to check at Würth Elektronik eiSos homepage for any updates. Your continued usage of the products will be deemed as the acceptance of the change.

We recommend you to be updated about the status of new firmware and software, which is available on our website or in our data sheet and manual, and to implement new software in your device where appropriate.

By ordering a product, you accept these license terms in all terms.

## List of Figures

1.	Block diagram of the module variants with internal PCB antenna and antenna pad	14
2.	Typical behavior of transmit and receive current in relation to applied supply voltage	18
3.	Pinout (top view)	20
4.	Power up	24
5.	Wake-up from standby	85
6.	Wake-up from shutdown	85
7.	Range extension using several repeaters	91
8.	Example network	94
9.	Listen Before Talk	95
10.	Layout	102
11.	Placement of the module with integrated antenna	103
12.	Dimensioning the antenna connection as micro strip	104
13.	Hermippe-III dipole antenna	106
14.	Hydra-I dipole antenna	107
15.	Assembly diagram	111
16.	Top and Bottom Layer	112
17.	Antenna characteristic from integrated antenna measured on official EV-Board <sup>1</sup>	113
18.	Reflow soldering profile	115
19.	Module dimensions [mm]	121
20.	Footprint and dimensions [mm]	122
21.	Lot number structure	123
22.	Label of the Telesto-III	124
23.	FCC certificate	127
24.	IC certificate	128

## List of Tables

1.	Ordering information	15
2.	Recommended operating conditions	16
3.	Absolute maximum ratings	16
4.	Power consumption @3.6 V	17
5.	Radio characteristics	19
6.	Pin characteristics	19
7.	Pinout	22
8.	Operating mode at start-up	26
9.	Communication in transparent mode	28
10.	Message overview	49
11.	Radio profiles	52
12.	Channel assignment	87
14.	Classification reflow soldering profile, Note: refer to IPC/JEDEC J-STD-020E	114
15.	Dimensions	120
16.	Weight	120
17.	Lot number details	123
18.	CRC8 Test Vectors	135



## A. Additional CRC8 Information

This Annex gives an example CRC8 implementation and test vectors.

### A.1. Example CRC8 Implementation

```
#include <stdint.h>

uint8_t Get_CRC8(uint8_t * bufP, uint16_t len)
{
    uint8_t crc = 0x00;
    for (uint16_t i = 0; i < len; i++)
    {
        crc ^= bufP[i];
    }
    return crc;
}
```

Code 1: Example CRC8 Implementation

### A.2. CRC8 Test Vectors

Input data	Data length	Resulting CRC8
Null	0	0x00
0x02 0x01 0x00 0x00	4	0x03
0x02 0x87 0x01 0x00 0x16	5	0x92
0x02 0x04 0x04 0x00 0x41 0x42 0x43 0x44	8	0x06
0x02 0x88 0x07 0x00 0x00 0x55 0x00 0x00 0xDA 0x18 0x00	11	0x1A

Table 18: CRC8 Test Vectors

## B. Example code for host integration

The following code is an example implementation of a function to transmit data using a 1 byte length field in the command frame. For demonstration reasons, the Tarvos-III has been taken. The full function codes of all radio modules are available in the Wireless Connectivity SDK ([www.we-online.com/wco-SDK](http://www.we-online.com/wco-SDK)).

```
#define CMD_PAYLOAD_MAX 224
typedef struct {
uint8_t Stx;
uint8_t Cmd;
uint8_t Length;
uint8_t Data[CMD_PAYLOAD_MAX+1]; /* +1 for CRC8 */
} CMD_Frame_t;
#define CMD_OFFSET_TO_DATAFIELD 3
#define CMD_OVERHEAD (CMD_OFFSET_TO_DATAFIELD+1)

bool TarvosIII_Transmit(uint8_t *PayloadP, uint8_t length)
{
/* fill request message with STX, command byte and length field */
CMD_Frame_t CMD_Frame;
CMD_Frame.Stx = CMD_STX; /* 0x02 */
CMD_Frame.Cmd = TarvosIII_CMD_DATA_REQ; /* 0x00 */
CMD_Frame.Length = length;

/* fill request message with user payload */
memcpy(CMD_Frame.Data, PayloadP, length);

/* fill request message with CRC8 */
CMD_Frame.Data[CMD_Frame.Length] = Get_CRC8(&CMD_Frame, CMD_Frame.Length +
    CMD_OFFSET_TO_DATAFIELD);

/* transmit full message via UART to radio module */
UART_SendBytes(&CMD_Frame, (CMD_Frame.Length + CMD_OVERHEAD));

/* wait for response message from radio module */
return UART_Wait_for_Response(CMD_WAIT_TIME, TarvosIII_CMD_DATA_CNF, CMD_Status_Success, true)
;
}

```

Code 2: Example function implementation for radio modules with 1 byte length field



**Contact**

Würth Elektronik eiSos GmbH & Co. KG  
Division Wireless Connectivity & Sensors

Max-Eyth-Straße 1  
74638 Waldenburg  
Germany

Tel.: +49 651 99355-0  
Fax.: +49 651 99355-69  
[www.we-online.com/wireless-connectivity](http://www.we-online.com/wireless-connectivity)

**WÜRTH ELEKTRONIK** MORE THAN YOU EXPECT